

**Cassetti**  
Drawers / Tiroirs  
Schubladen / Cajones

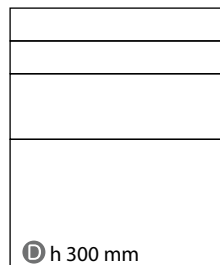

**Cassetti**  
Drawers / Tiroirs  
Schubladen / Cajones

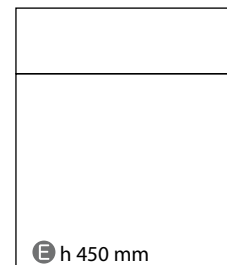

**Modulo sottolavello**  
Sink unit / Module lavabo  
Waschbeckenschrank  
Módulo bajo lavabo

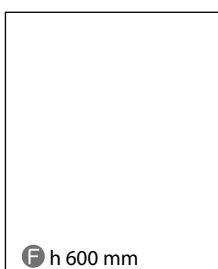

**Anta**  
Door / Porte  
Tür / Puerta

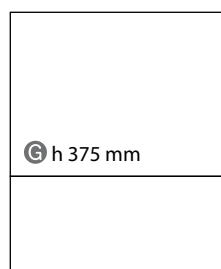

**Anta a ribalta**  
Hide-away door  
Porte basculante  
Versenkbare Tür  
Puerta escamoteable

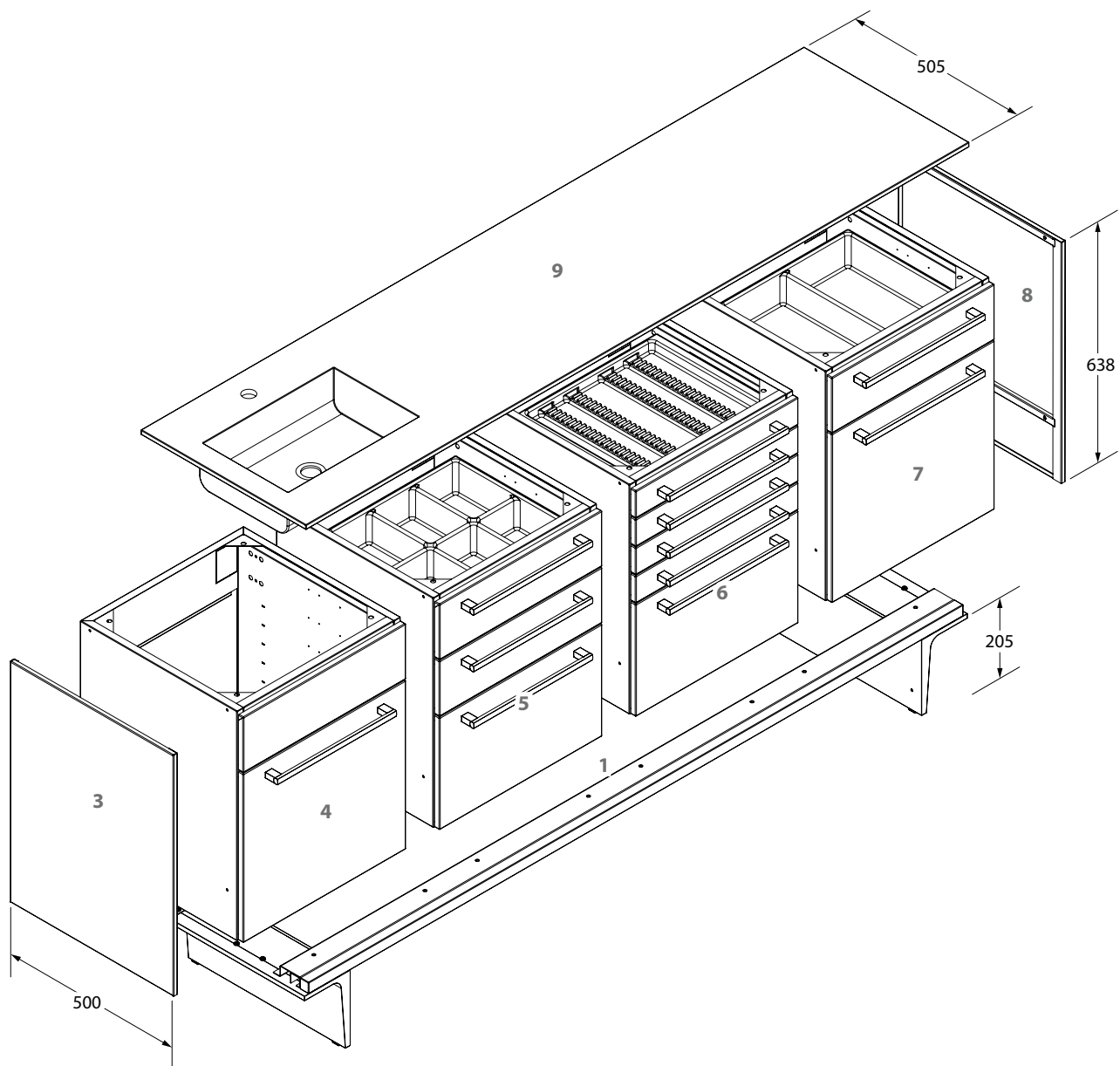

### MOBILE VELA

- 1** Supporto a pavimento
- 2** Bordo di finitura per versione a muro
- 3** Fianco laterale
- 4** Mobile lavello
- 5** Mobile con 2 cassetti B + 1D
- 6** Mobile con 4 cassetti A + 1D
- 7** Mobile con 1 cassetto B + anta
- 8** Fianco terminale dx
- 9** Piano con lavello sx
- 10** Sistema di aggancio per versione a muro

**H** Sottopiano 843 mm

### UNIT VELA

- 1** Floor support
- 2** Finish profile for wall support
- 3** Lateral side LH
- 4** Sink unit
- 5** Unit with 2 drawers B + 1 D
- 6** Unit with 4 drawers A + 1 D
- 7** Unit with 1 drawer B + door
- 8** Lateral side RH
- 9** Top with sink on the left side
- 10** Coupling system for wall support

**H** Under the top 843 mm

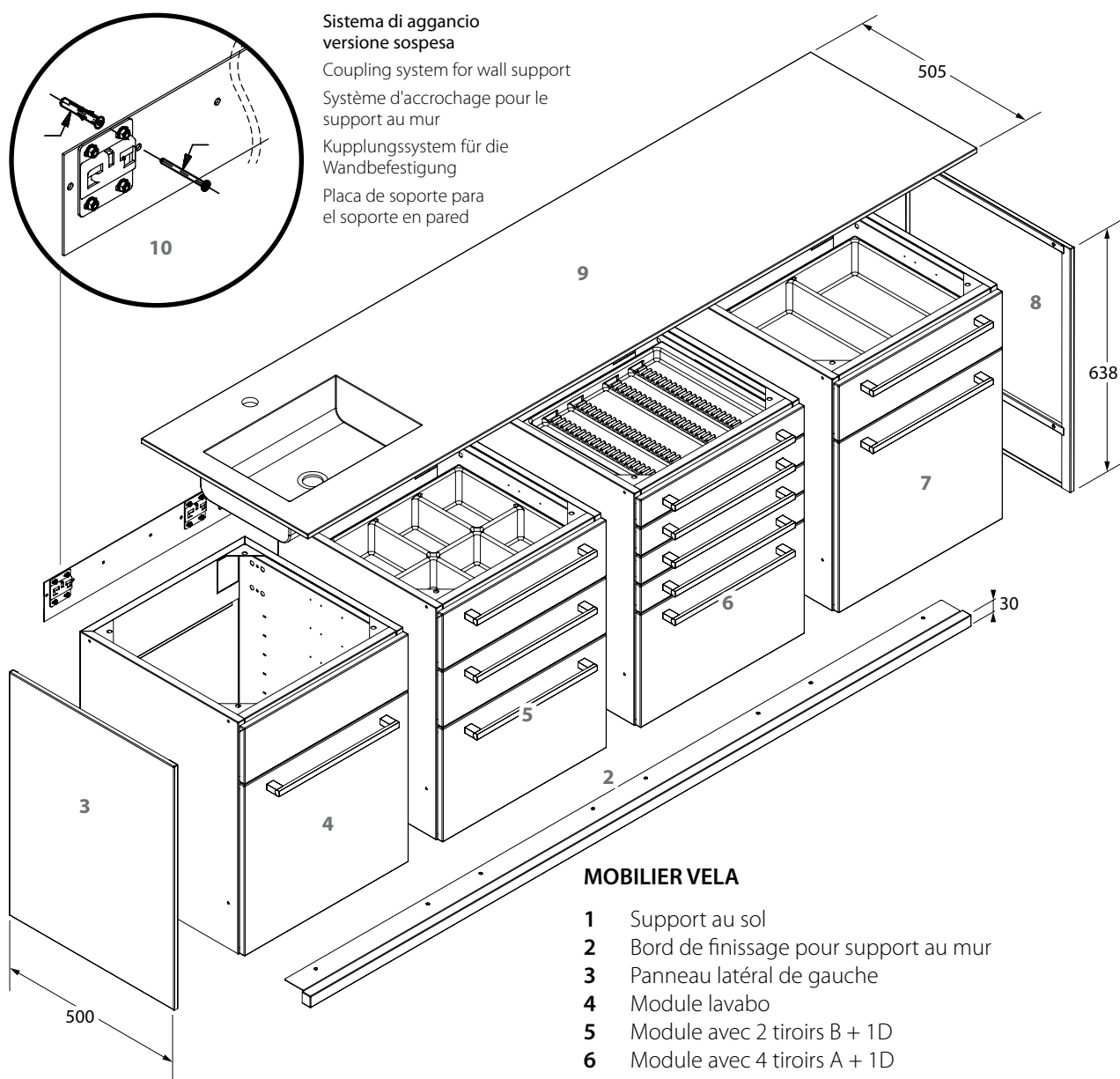

**Sistema di aggancio versione sospesa**

Coupling system for wall support

Système d'accrochage pour le support au mur

Kupplungssystem für die Wandbefestigung

Placa de soporte para el soporte en pared

**MOBILIER VELA**

- 1 Support au sol
- 2 Bord de finissage pour support au mur
- 3 Panneau latéral de gauche
- 4 Module lavabo
- 5 Module avec 2 tiroirs B + 1D
- 6 Module avec 4 tiroirs A + 1D
- 7 Module avec 1 tiroir B et porte
- 8 Panneau latéral de droite
- 9 Plan avec évier à gauche
- 10 Système d'accrochage pour le support au mur

**H** Sous plan de travail 843 mm

**VELA-MÖBEL**

- 1 Bodengestell
- 2 Abschlussleiste für die Wandbefestigung
- 3 Seitenwand links
- 4 Waschbeckenschrank
- 5 Schrank mit 2 Schubladen B und 1 D
- 6 Schrank mit 4 Schubladen A und 1 D
- 7 Schrank mit 1 Schublade B und Tür
- 8 Seitenwand rechts
- 9 Arbeitsplatte mit Waschbecken links
- 10 Kupplungssystem für die Wandbefestigung

**H** Unter der Arbeitsplatte 843 mm

**MUEBLE VELA**

- 1 Soporte de pie
- 2 Borde de acabado para soporte en pared
- 3 Panel lateral izq.
- 4 Módulo bajo lavabo
- 5 Módulo con 2 cajones B + 1D
- 6 Módulo con 4 cajones A + 1D
- 7 Módulo con 1 cajón B + puerta
- 8 Panel lateral dcho.
- 9 Encimera con lavabo izq.
- 10 Placa de soporte para el soporte en pared

**A** Bajo encimera 843 mm

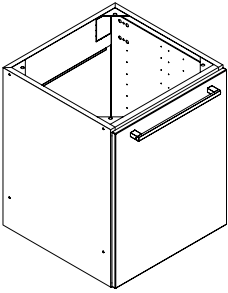
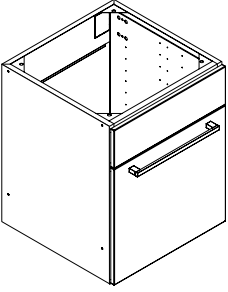
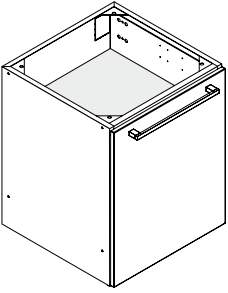
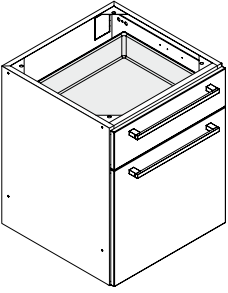
|   | <b>Descrizione / Description</b><br>Description / Beschreibung / Descripción | <b>Apertura</b><br>Opening / Ouverture<br>Öffnung / Apertura | <b>M<sup>3</sup></b><br><b>Kg</b> | <b>Articolo</b><br>Item / Article<br>Artikel / Artículo |
|---|--|--|-----------------------------------|---|
|  <p><b>MODULO sottolavello con anta e portarifiuti interno</b><br/>Sink unit with door and rubbish bin<br/>Module lavabo avec porte et poubelle<br/>Waschbeckenschrank mit Tür und Abfalleimer<br/>Módulo lavabo con puerta y cubo de basura</p> <p><b>L 500 x P 498 x H 608 mm</b></p>  |  | <b>Maniglia</b><br>Handle<br>Poignée<br>Griff<br>Tirador     | $\frac{0,25}{20,5}$               | VLAM  |
|   |  | <b>Push-Pull</b>   | $\frac{0,25}{20,3}$               | VLAP  |
|  <p><b>MODULO sottolavello con frontale fisso e anta "VLB" o con cassetto estraibile "VLC", con portarifiuti interno</b><br/>Sink unit with fixed front and door "VLB" or pullout drawer "VLC", with rubbish bin<br/>Module lavabo avec façade fixe et porte "VLB" ou grand tiroir extractible "VLC", avec poubelle<br/>Waschbeckenschrank mit fest Frontplatte und Tür "VLB" oder Schublade "VLC", mit Abfalleimer<br/>Módulo lavabo con frente fijo y puerta "VLB" o cajón "VLC", con cubo de basura</p> <p><b>L 500 x P 498 x H 608 mm</b></p> |  | <b>Maniglia</b><br>Handle<br>Poignée<br>Griff<br>Tirador     | $\frac{0,25}{21}$                 | VLBM  |
|   |  |  | $\frac{0,25}{25,5}$               | VLCM  |
|   |  |  | $\frac{0,25}{20,8}$               | VLBP  |
|   |  | <b>Push-Pull</b>   | $\frac{0,25}{25,3}$               | VLCP  |
|  <p><b>MODULO con anta e due ripiani interni</b><br/>Unit with door and 2 interior shelves<br/>Module avec porte et 2 étagères internes<br/>Schränk mit Tür und 2 Einlegeböden<br/>Módulo con puerta y dos estantes interiores</p> <p><b>L 500 x P 498 x H 608 mm</b></p>  |  | <b>Maniglia</b><br>Handle<br>Poignée<br>Griff<br>Tirador     | $\frac{0,25}{20,5}$               | VPAM  |
|   |  | <b>Push-Pull</b>   | $\frac{0,25}{20,3}$               | VPAP  |
|  <p><b>MODULO con cassetto B e anta con 1 ripiano interno</b><br/>Unit with drawer B and door with an interior shelf<br/>Module avec 1 tiroir B et porte avec 1 étagère à l'intérieur<br/>Schränk mit 1 Schublade B und Tür mit 1 Einlegeboden<br/>Módulo con cajón B y puerta con 1 estante interior</p> <p><b>L 500 x P 498 x H 608 mm</b></p>   |  | <b>Maniglia</b><br>Handle<br>Poignée<br>Griff<br>Tirador     | $\frac{0,25}{25}$                 | VPBM  |
|   |  | <b>Push-Pull</b>   | $\frac{0,25}{24,6}$               | VPBP  |

Bacinelle / Trays / Intérieurs de tiroir  
Einsätze / Cubetas: 1xVBB1

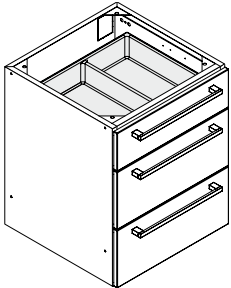
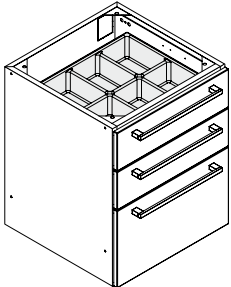
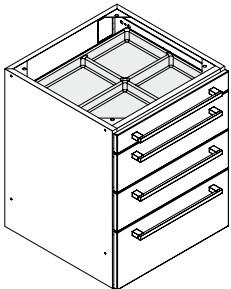
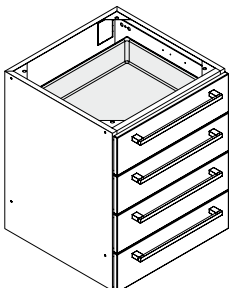
|   | <b>Descrizione / Description</b><br>Description / Beschreibung / Descripción | <b>Apertura</b><br>Opening / Ouverture<br>Öffnung / Apertura | <b>M<sup>3</sup></b><br><b>Kg</b> | <b>Articolo</b><br>Item / Article<br>Artikel / Artículo |
|---|--|--|-----------------------------------|---|
|  <p><b>MODULO con 3 cassetti: 1 B e 2 C</b><br/>Unit with 3 drawers: 1 B and 2 C<br/>Module avec 3 tiroirs: 1 B et 2 C<br/>Schrank mit 3 Schubladen: 1 B und 2 C<br/>Módulo con 3 cajones: 1 B y 2 C</p> <p><b>Bacelle / Trays / Intérieurs de tiroir / Einsätze /<br/>Bandejas: 1xVBB2, 2xVBC1</b></p> <p><b>L 500 x P 498 x H 608 mm</b></p>   |  | <b>Maniglia</b><br>Handle<br>Poignée<br>Griff<br>Tirador     | 0,25<br>-----<br>35,2             | V3AM  |
|   |  | <b>Push-Pull</b>   | 0,25<br>-----<br>34,6             | V3AP  |
|  <p><b>MODULO con 3 cassetti: 2 B e 1 D</b><br/>Unit with 3 drawers: 2 B and 1 D<br/>Module avec 3 tiroirs: 2 B et 1 D<br/>Schrank mit 3 Schubladen: 2 B und 1 D<br/>Módulo con 3 cajones: 2 B y 1 D</p> <p><b>Bacelle / Trays / Intérieurs de tiroir / Einsätze /<br/>Bandejas: 1xVBB2, 1xVBB4, 1xVBC1</b></p> <p><b>L 500 x P 498 x H 608 mm</b></p>                                  |  | <b>Maniglia</b><br>Handle<br>Poignée<br>Griff<br>Tirador     | 0,25<br>-----<br>35               | V3BM  |
|   |  | <b>Push-Pull</b>   | 0,25<br>-----<br>34,4             | V3BP  |
|  <p><b>MODULO con 4 cassetti: 1 A, 2 B e 1 C</b><br/>Unit with 4 drawers: 1 A, 2 B and 1 C<br/>Module avec 4 tiroirs: 1 A, 2 B et 1 C<br/>Schrank mit 4 Schubladen: 1 A, 2 B und 1 C<br/>Módulo con 4 cajones: 1 A, 2B y 1 C</p> <p><b>Bacelle / Trays / Intérieurs de tiroir / Einsätze /<br/>Bandejas: 1xVBA3, 1xVBB1, 1xVBB2, 1xVBC1</b></p> <p><b>L 500 x P 498 x H 608 mm</b></p> |  | <b>Maniglia</b><br>Handle<br>Poignée<br>Griff<br>Tirador     | 0,25<br>-----<br>40,2             | V4AM  |
|   |  | <b>Push-Pull</b>   | 0,25<br>-----<br>39,4             | V4AP  |
|  <p><b>MODULO con 4 cassetti: 4 B</b><br/>Unit with 4 drawers: 4 B<br/>Module avec 4 tiroirs: 4 B<br/>Schrank mit 4 Schubladen: 4 B<br/>Módulo con 4 cajones: 4 B</p> <p><b>Bacelle / Trays / Intérieurs de tiroir / Einsätze /<br/>Bandejas: 1xVBB1, 1xVBB2, 1xVBB3, 1xVBB4</b></p> <p><b>L 500 x P 498 x H 608 mm</b></p>  |  | <b>Maniglia</b><br>Handle<br>Poignée<br>Griff<br>Tirador     | 0,25<br>-----<br>40,4             | V4BM  |
|   |  | <b>Push-Pull</b>   | 0,25<br>-----<br>39,6             | V4BP  |

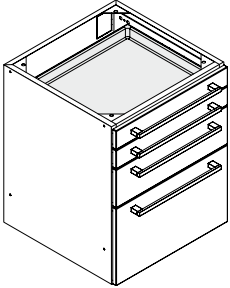
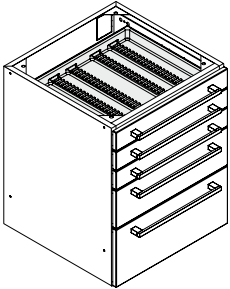
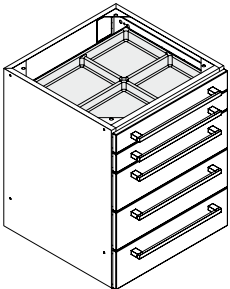
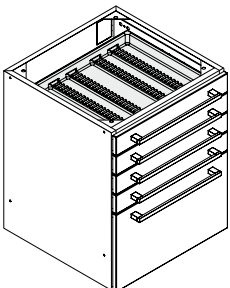
|  | <b>Descrizione / Description</b><br>Description / Beschreibung / Descripción   | <b>Apertura</b><br>Opening / Ouverture<br>Öffnung / Apertura | <b>M<sup>3</sup></b><br><b>Kg</b> | <b>Articolo</b><br>Item / Article<br>Artikel / Artículo |
|--|--|--|-----------------------------------|---|
| <br><b>L 500 x P 498 x H 608 mm</b>   | <b>MODULO con 4 cassetti: 2 A, 1 B e 1 D</b><br>Unit with 4 drawers: 2 A, 1 B and 1 D<br>Module avec 4 tiroirs: 2 A, 1 B et 1 D<br>Schrank mit 4 Schubladen: 2 A, 1 B und 1 D<br>Módulo con 4 cajones: 2 A, 1 B y 1 D<br><br><b>Bacinelle / Trays / Intérieurs de tiroir</b><br><b>Einsätze / Bandejas:</b><br><b>1xVBA2, 1xVBA4, 1xVBB4, 1xVBC1</b>         | <b>Maniglia</b><br>Handle<br>Poignée<br>Griff<br>Tirador     | 0,25<br><hr/> 39,8                | V4CM  |
|  |  | <b>Push-Pull</b>   | 0,25<br><hr/> 39                  | V4CP  |
| <br><b>L 500 x P 498 x H 608 mm</b>  | <b>MODULO con 5 cassetti: 3 A, 1 B e 1 C</b><br>Unit with 5 drawers: 3 A, 1 B and 1 C<br>Module avec 5 tiroirs: 3 A, 1 B et 1 C<br>Schrank mit 5 Schubladen: 3 A, 1 B und 1 C<br>Módulo con 5 cajones: 3 A, 1 B y 1 C<br><br><b>Bacinelle / Trays / Intérieurs de tiroir</b><br><b>Einsätze / Bandejas:</b><br><b>1xVBA1, 1xVBA3, 1xVBA4, 1xVBB1, 1xVBC1</b> | <b>Maniglia</b><br>Handle<br>Poignée<br>Griff<br>Tirador     | 0,25<br><hr/> 45                  | V5AM  |
|  |  | <b>Push-Pull</b>   | 0,25<br><hr/> 44                  | V5AP  |
| <br><b>L 500 x P 498 x H 608 mm</b> | <b>MODULO con 5 cassetti: 2 A e 3 B</b><br>Unit with 5 drawers: 2 A and 3 B<br>Module avec 5 tiroirs: 2 A et 3 B<br>Schrank mit 5 Schubladen: 2 A und 3 B<br>Módulo con 5 cajones: 2 A y 3 B<br><br><b>Bacinelle / Trays / Intérieurs de tiroir</b><br><b>Einsätze / Bandejas:</b><br><b>1xVBA3, 1xVBA4, 1xVBB1, 1xVBB2, 1xVBB4</b>                          | <b>Maniglia</b><br>Handle<br>Poignée<br>Griff<br>Tirador     | 0,25<br><hr/> 45,2                | V5BM  |
|  |  | <b>Push-Pull</b>   | 0,25<br><hr/> 44,2                | V5BP  |
| <br><b>L 500 x P 498 x H 608 mm</b> | <b>MODULO con 5 cassetti: 4 A e 1 D</b><br>Unit with 5 drawers: 4 A and 1 D<br>Module avec 5 tiroirs: 4 A et 1 D<br>Schrank mit 5 Schubladen: 4 A und 1 D<br>Módulo con 5 cajones: 4 A y 1 D<br><br><b>Bacinelle / Trays / Intérieurs de tiroir</b><br><b>Einsätze / Bandejas:</b><br><b>1xVBA1, 1xVBA2, 1xVBA3, 1xVBA4, 1xVBC1</b>                          | <b>Maniglia</b><br>Handle<br>Poignée<br>Griff<br>Tirador     | 0,25<br><hr/> 44,6                | V5CM  |
|  |  | <b>Push-Pull</b>   | 0,25<br><hr/> 43,6                | V5CP  |

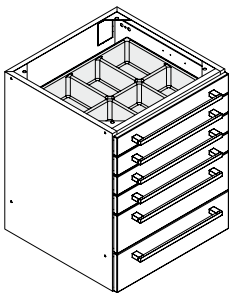
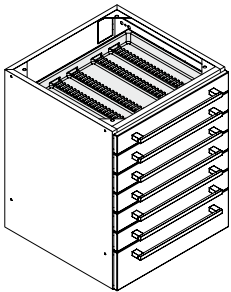
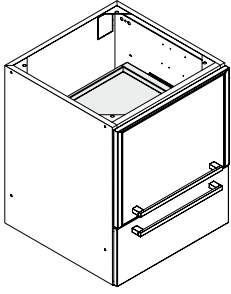
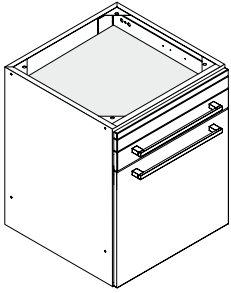
|   | Descrizione / Description<br>Description / Beschreibung / Descripción | Apertura<br>Opening / Ouverture<br>Öffnung / Apertura                             | M <sup>3</sup><br>Kg | Articolo<br>Item / Article<br>Artikel / Artículo |
|---|---|---|----------------------|--|
|  <p><b>MODULO con 6 cassetti: 4 A e 2 B</b><br/>Unit with 6 drawers: 4 A and 2 B<br/>Module avec 6 tiroirs: 4 A et 2 B<br/>Schrank mit 6 Schubladen: 4 A und 2 B<br/>Módulo con 6 cajones: 4 A y 2 B</p> <p><b>Bacelle / Trays / Intérieurs de tiroir / Einsätze / Bandejas: 1xVBA1, 1xVBA2, 1xVBA3, 1xVBA4, 1xVBB1, 1xVBB4</b></p> <p><b>L 500 x P 498 x H 608 mm</b></p>   |   | <p>Maniglia<br/>Handle<br/>Poignée<br/>Griff<br/>Tirador</p> <p>0,25<br/>50</p>   |                      | V6AM   |
|   |   | <p>Push-Pull</p> <p>0,25<br/>48,8</p>   |                      | V6AP   |
|  <p><b>MODULO con 7 cassetti: 6 A e 1 B</b><br/>Unit with 7 drawers: 6 A and 1 B<br/>Module avec 7 tiroirs: 6 A et 1 B<br/>Schrank mit 7 Schubladen: 6 A et 1 B<br/>Módulo con 7 cajones: 6 A y 1 B</p> <p><b>Bacelle / Trays / Intérieurs de tiroir / Einsätze / Bandejas: 1xVBA1, 2xVBA2, 2xVBA3, 1xVBA4, 1xVBB3</b></p> <p><b>L 500 x P 498 x H 608 mm</b></p>   |   | <p>Maniglia<br/>Handle<br/>Poignée<br/>Griff<br/>Tirador</p> <p>0,25<br/>54,8</p> |                      | V7AM   |
|   |   | <p>Push-Pull</p> <p>0,25<br/>53,4</p>   |                      | V7AP   |
|  <p><b>MODULO con anta a ribalta con 2 ripiani estraibili per apparecchiature + ciabatta con 4 prese di corrente e cassetto C</b><br/>Unit with hide-away door equipped with 2 apparatus storage shelves + 4 Schuko sockets and 1 drawer C<br/>Module avec porte basculante avec 2 tiroirs pour appareils + 4 prises de courant Schuko et 1 tiroir C<br/>Schrank mit versenkbarer Tür mit 2 Geräteeinlagen + 4 Schuko-Steckdosen und 1 Schublade C<br/>Módulo con puerta plegable con 2 estantes extraíbles para equipos + regleta con 4 tomas de corriente Schuko y cajón C</p> <p><b>Bacelle / Trays / Intérieurs de tiroir / Einsätze / Bandejas: 1xVBC1</b></p> <p><b>L 500 x P 498 x H 608 mm</b></p> |   | <p>Maniglia<br/>Handle<br/>Poignée<br/>Griff<br/>Tirador</p> <p>0,25<br/>33</p>   |                      | VRAM   |
|   |   | <p>Push-Pull</p> <p>0,25<br/>32,6</p>   |                      | VRAP   |
|  <p><b>MODULO PC con cassetto A per tastiera (L 385 - H 30 mm max), 1 cassetto A e anta, con schiena aperta</b><br/>Unit for PC with 1 drawer A for keyboard (L - H), 1 drawer A and door, open back<br/>Module pour PC avec 1 tiroir A pour clavier (L - H), 1 tiroir A et porte, ouvert derrière<br/>Schrank für PC mit 1 Schublade A für Tastatur (L - H), 1 Schublade A und Tür, Rückwand geöffnet<br/>Módulo PC con 1 cajón A porta teclado (L - H), 1 cajón A y puerta, con panel trasero abierto</p> <p><b>L 500 x P 498 x H 608 mm</b></p>   |   | <p>Maniglia<br/>Handle<br/>Poignée<br/>Griff<br/>Tirador</p> <p>0,25<br/>25</p>   |                      | VPCM   |
|   |   | <p>Push-Pull</p> <p>0,25<br/>24,8</p>   |                      | VPCP   |

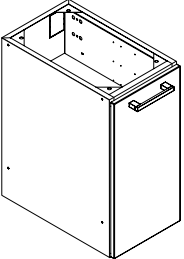
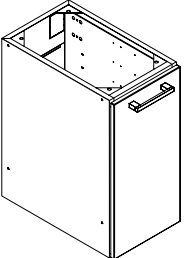
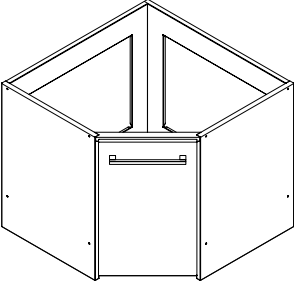
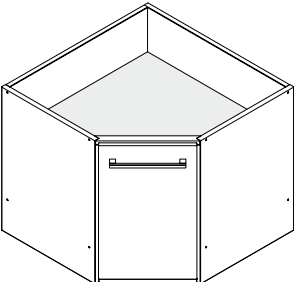
|  | Descrizione / Description<br>Description / Beschreibung / Descripción   | Apertura<br>Opening / Ouverture<br>Öffnung / Apertura | M <sup>3</sup><br>Kg | Articolo<br>Item / Article<br>Artikel / Artículo |
|--|---|---|----------------------|--|
|  <p><b>L 300/400 x P 498 x H 608 mm</b></p> | <p><b>MODULO con anta e due ripiani interni</b></p> <p>Unit with door and 2 interior shelves</p> <p>Module avec porte et 2 étagères internes</p> <p>Schrank mit Tür und 2 Einlegeböden</p> <p>Módulo con puerta y dos estantes interiores</p>   | Maniglia<br>Handle<br>Poignée<br>Griff<br>Tirador     | 0,25<br>16           | VPDM<br>(L. 300 mm)                              |
|  |   |   | 0,25<br>17           | VPGM<br>(L. 400 mm)                              |
|  |   | Push-Pull   | 0,25<br>15,9         | VPDP<br>(L. 300 mm)                              |
|  |   |   | 0,25<br>16,9         | VPGP<br>(L. 400 mm)                              |
|  <p><b>L 300 x P 498 x H 608 mm</b></p>    | <p><b>MODULO con anta e due ripiani interni, con schiena aperta</b></p> <p>Unit with door and 2 interior shelves, open back</p> <p>Module avec porte et 2 étagères internes, ouvert derrière</p> <p>Schrank mit Tür und 2 Einlegeböden, Rückwand geöffnet</p> <p>Módulo con puerta y dos estantes interiores, con panel trasero abierto</p> | Maniglia<br>Handle<br>Poignée<br>Griff<br>Tirador     | 0,25<br>15,5         | VPEM   |
|  |   | Push-Pull   | 0,23<br>15,4         | VPEP   |
|  |   |   |                      |  |
|  |   |   |                      |  |
|  <p><b>L 750 x P 750 x H 608 mm</b></p>   | <p><b>MODULO angolare sottolavello con anta e portarifiuti interno</b></p> <p>Corner sink unit with door and rubbish bin</p> <p>Module lavabo d'angle avec porte et poubelle</p> <p>Eckwaschbeckenschrank mit Tür und Abfalleimer</p> <p>Módulo angular lavabo con puerta y cubo de basura</p>  | Maniglia<br>Handle<br>Poignée<br>Griff<br>Tirador     | 0,70<br>17,5         | VAAM   |
|  |   | Push-Pull   | 0,70<br>17,4         | VAAP   |
|  |   |   |                      |  |
|  |   |   |                      |  |
|  <p><b>L 750 x P 750 x H 608 mm</b></p>   | <p><b>MODULO angolare con anta e 1 ripiano interno</b></p> <p>Corner unit with door and 1 interior shelf</p> <p>Module d'angle avec porte et 1 étagère interne</p> <p>Eckschrank mit Tür und 1 Einlegeboden</p> <p>Módulo angular con puerta y estante interior</p>   | Maniglia<br>Handle<br>Poignée<br>Griff<br>Tirador     | 0,70<br>22           | VACM   |
|  |   | Push-Pull   | 0,70<br>21,9         | VACP   |
|  |   |   |                      |  |
|  |   |   |                      |  |

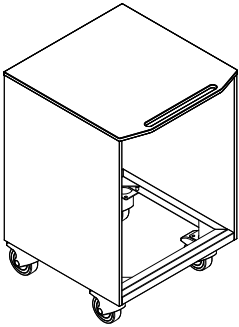
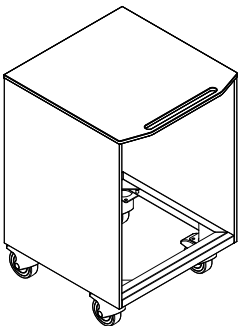
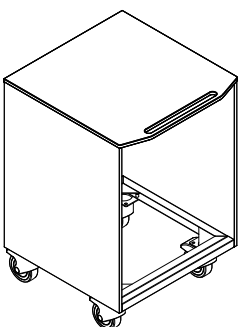

|   | <b>Descrizione / Description</b><br>Description / Beschreibung / Descripción   | <b>Fianchi</b><br>Sides / Côtés<br>Seiten / Laterales                            | <b>M<sup>3</sup></b><br><b>Kg</b> | <b>Articolo</b><br>Item / Article<br>Artikel / Artículo |
|---|--|--|-----------------------------------|---|
|  <p><b>Kit ruote + piano sagomato in Corian® bianco</b><br/>                     Castor set + shaped white Corian® top<br/>                     Kit roues + plan façonné en Corian® blanc<br/>                     Rollenset + Arbeitsplatte aus geformtem weißem Corian®<br/>                     Kit de ruedas + encimera perfilada de Corian® blanco</p> <p><b>L 528 x P 555 x H 787 mm</b></p>                       |  | <b>Verniciato</b><br>Painted / Verni<br>Lackiert<br>Pintado                      | 0,08<br>-----<br>21               | KRCV  |
|   |  | <b>Stratificato</b><br>Stratified / Stratifié<br>Schichtstoff<br>Estratificado   | 0,08<br>-----<br>26,4             | KRCS  |
|   |  | <b>Corian®</b>   | 0,08<br>-----<br>28               | KRCC  |
|  <p><b>Kit ruote + piano sagomato in stratificato bianco</b><br/>                     Castor set + shaped white stratified top<br/>                     Kit roues + plan façonné en stratifié blanc<br/>                     Rollenset + Arbeitsplatte aus geformtem weißem Schichtstoff<br/>                     Kit de ruedas + encimera perfilada de estratificado blanco</p> <p><b>L 528 x P 555 x H 787 mm</b></p> |  | <b>Verniciato</b><br>Painted / Verni<br>Lackiert<br>Pintado                      | 0,08<br>-----<br>20,3             | KRSV  |
|   |  | <b>Stratificato</b><br>Stratified / Stratifié<br>Schichtstoff<br>Estratificado   | 0,08<br>-----<br>25,7             | KRSS  |
|   |  | <b>Corian®</b>   | 0,08<br>-----<br>27,3             | KRSC  |
|  <p><b>Kit ruote + piano sagomato in vetro</b><br/>                     Castor set + shaped glass top<br/>                     Kit roues + plan façonné en verre<br/>                     Rollenset + geformte Glasarbeitsplatte<br/>                     Kit de ruedas + encimera perfilada de vidrio</p> <p><b>L 528 x P 555 x H 790 mm</b></p>  |  | <b>Verniciato</b><br>Painted / Verni<br>Lackiert<br>Pintado                      | 0,08<br>-----<br>25,6             | KRWV  |
|   |  | <b>Stratificato</b><br>Stratified / Stratifié<br>Schichtstoff<br>Estratificado   | 0,08<br>-----<br>31               | KRVS  |
|   |  | <b>Corian®</b>   | 0,08<br>-----<br>32,6             | KRVC  |
|   | <b>MAGGIORAZIONI per piano in vetro</b><br>Additional charge for glass top<br>Supplément de prix pour plan en verre<br>Aufpreis für Glasarbeitsplatte<br>Cargo adicional para encimera de vidrio | <b>Extra-chiaro</b><br>Extra clear<br>Transparent<br>Transparent<br>Transparente |                                   |   |
|   |  | <b>Satinato</b><br>Satin / Dépoli<br>Satinert<br>Satinado                        |                                   |   |

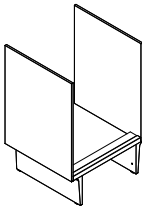
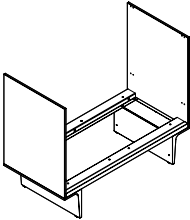
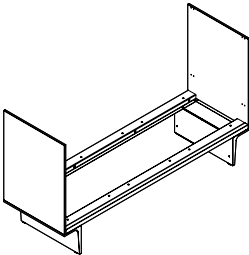
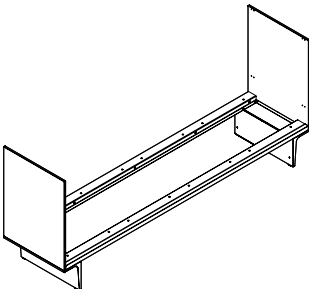
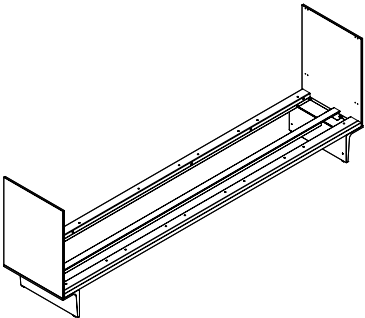
|   | <b>Descrizione / Description</b><br>Description / Beschreibung / Descripción   | <b>Fianchi</b><br>Sides / Côtés<br>Seiten / Laterales                          | <b>M<sup>3</sup></b><br><b>Kg</b> | <b>Articolo</b><br>Item / Article<br>Artikel / Artículo |
|---|--|--|-----------------------------------|---|
| <br><b>L 528 mm</b>    | <b>SUPPORTO a pavimento per 1 modulo</b><br>Floor support for 1 unit<br>Support au sol pour 1 module<br>Bodengestell für 1 Schrank<br>Soporte de pie para 1 módulo     | <b>Verniciato</b><br>Painted / Verni<br>Lackiert<br>Pintado                    | 0,14<br><hr/> 26                  | VS1V  |
|   |  | <b>Stratificato</b><br>Stratified / Stratifié<br>Schichtstoff<br>Estratificado | 0,14<br><hr/> 31                  | VS1S  |
|   |  | <b>Corian®</b>   | 0,14<br><hr/> 33                  | VS1C  |
| <br><b>L 1028 mm</b>   | <b>SUPPORTO a pavimento per 2 moduli</b><br>Floor support for 2 units<br>Support au sol pour 2 modules<br>Bodengestell für 2 Schränke<br>Soporte de pie para 2 módulos | <b>Verniciato</b><br>Painted / Verni<br>Lackiert<br>Pintado                    | 0,26<br><hr/> 34                  | VS2V  |
|   |  | <b>Stratificato</b><br>Stratified / Stratifié<br>Schichtstoff<br>Estratificado | 0,26<br><hr/> 39                  | VS2S  |
|   |  | <b>Corian®</b>   | 0,26<br><hr/> 41                  | VS2C  |
| <br><b>L 1528 mm</b> | <b>SUPPORTO a pavimento per 3 moduli</b><br>Floor support for 3 units<br>Support au sol pour 3 modules<br>Bodengestell für 3 Schränke<br>Soporte de pie para 3 módulos | <b>Verniciato</b><br>Painted / Verni<br>Lackiert<br>Pintado                    | 0,35<br><hr/> 38                  | VS3V  |
|   |  | <b>Stratificato</b><br>Stratified / Stratifié<br>Schichtstoff<br>Estratificado | 0,35<br><hr/> 43                  | VS3S  |
|   |  | <b>Corian®</b>   | 0,35<br><hr/> 45                  | VS3C  |
| <br><b>L 2028 mm</b> | <b>SUPPORTO a pavimento per 4 moduli</b><br>Floor support for 4 units<br>Support au sol pour 4 modules<br>Bodengestell für 4 Schränke<br>Soporte de pie para 4 módulos | <b>Verniciato</b><br>Painted / Verni<br>Lackiert<br>Pintado                    | 0,40<br><hr/> 42                  | VS4V  |
|   |  | <b>Stratificato</b><br>Stratified / Stratifié<br>Schichtstoff<br>Estratificado | 0,40<br><hr/> 47                  | VS4S  |
|   |  | <b>Corian®</b>   | 0,40<br><hr/> 49                  | VS4C  |
| <br><b>L 2528 mm</b> | <b>SUPPORTO a pavimento per 5 moduli</b><br>Floor support for 5 units<br>Support au sol pour 5 modules<br>Bodengestell für 5 Schränke<br>Soporte de pie para 5 módulos | <b>Verniciato</b><br>Painted / Verni<br>Lackiert<br>Pintado                    | 0,54<br><hr/> 57                  | VS5V  |
|   |  | <b>Stratificato</b><br>Stratified / Stratifié<br>Schichtstoff<br>Estratificado | 0,54<br><hr/> 62                  | VS5S  |
|   |  | <b>Corian®</b>   | 0,54<br><hr/> 64                  | VS5C  |

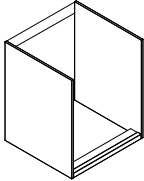
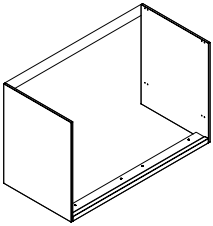
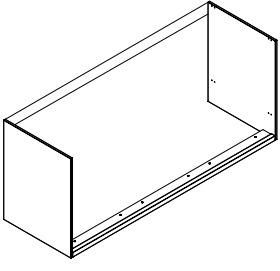
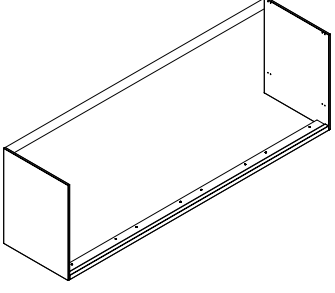
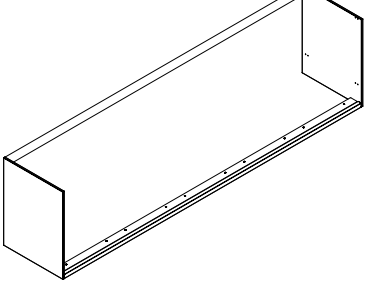
|   | <b>Descrizione / Description</b><br>Description / Beschreibung / Descripción  | <b>Fianchi</b><br>Sides / Côtés<br>Seiten / Laterales                          | <b>M<sup>3</sup></b><br><b>Kg</b> | <b>Articolo</b><br>Item / Article<br>Artikel / Artículo |
|---|---|--|-----------------------------------|---|
| <br><b>L 528 mm</b>    | <b>SUPPORTO a muro per 1 modulo</b><br>Wall support for 1 unit<br>Support au mur pour 1 module<br>Wandbefestigung für 1 Schrank<br>Soporte de pared para 1 módulo     | <b>Verniciato</b><br>Painted / Verni<br>Lackiert<br>Pintado                    | $\frac{0,01}{10}$                 | VM1V  |
|   |   | <b>Stratificato</b><br>Stratified / Stratifié<br>Schichtstoff<br>Estratificado | $\frac{0,01}{15}$                 | VM1S  |
|   |   | <b>Corian®</b>   | $\frac{0,01}{17}$                 | VM1C  |
| <br><b>L 1028 mm</b>   | <b>SUPPORTO a muro per 2 moduli</b><br>Wall support for 2 units<br>Support au mur pour 2 modules<br>Wandbefestigung für 2 Schränke<br>Soporte de pared para 2 módulos | <b>Verniciato</b><br>Painted / Verni<br>Lackiert<br>Pintado                    | $\frac{0,02}{12,5}$               | VM2V  |
|   |   | <b>Stratificato</b><br>Stratified / Stratifié<br>Schichtstoff<br>Estratificado | $\frac{0,02}{17,5}$               | VM2S  |
|   |   | <b>Corian®</b>   | $\frac{0,02}{19,5}$               | VM2C  |
| <br><b>L 1528 mm</b> | <b>SUPPORTO a muro per 3 moduli</b><br>Wall support for 3 units<br>Support au mur pour 3 modules<br>Wandbefestigung für 3 Schränke<br>Soporte de pared para 3 módulos | <b>Verniciato</b><br>Painted / Verni<br>Lackiert<br>Pintado                    | $\frac{0,03}{14,5}$               | VM3V  |
|   |   | <b>Stratificato</b><br>Stratified / Stratifié<br>Schichtstoff<br>Estratificado | $\frac{0,03}{19,5}$               | VM3S  |
|   |   | <b>Corian®</b>   | $\frac{0,03}{21,5}$               | VM3C  |
| <br><b>L 2028 mm</b> | <b>SUPPORTO a muro per 4 moduli</b><br>Wall support for 4 units<br>Support au mur pour 4 modules<br>Wandbefestigung für 4 Schränke<br>Soporte de pared para 4 módulos | <b>Verniciato</b><br>Painted / Verni<br>Lackiert<br>Pintado                    | $\frac{0,04}{17}$                 | VM4V  |
|   |   | <b>Stratificato</b><br>Stratified / Stratifié<br>Schichtstoff<br>Estratificado | $\frac{0,04}{22}$                 | VM4S  |
|   |   | <b>Corian®</b>   | $\frac{0,04}{24}$                 | VM4C  |
| <br><b>L 2528 mm</b> | <b>SUPPORTO a muro per 5 moduli</b><br>Wall support for 5 units<br>Support au mur pour 5 modules<br>Wandbefestigung für 5 Schränke<br>Soporte de pared para 5 módulos | <b>Verniciato</b><br>Painted / Verni<br>Lackiert<br>Pintado                    | $\frac{0,05}{21}$                 | VM5V  |
|   |   | <b>Stratificato</b><br>Stratified / Stratifié<br>Schichtstoff<br>Estratificado | $\frac{0,05}{26}$                 | VM5S  |
|   |   | <b>Corian®</b>   | $\frac{0,05}{28}$                 | VM5C  |

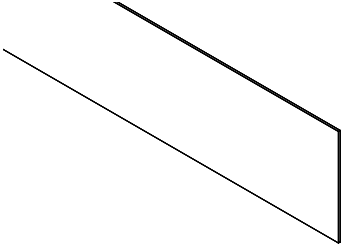
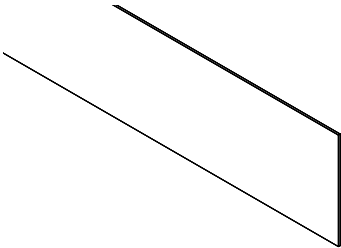
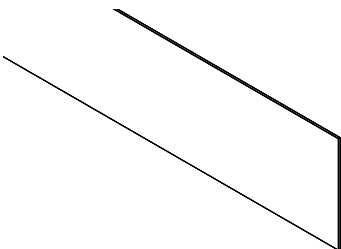
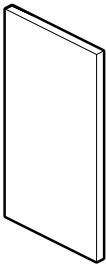
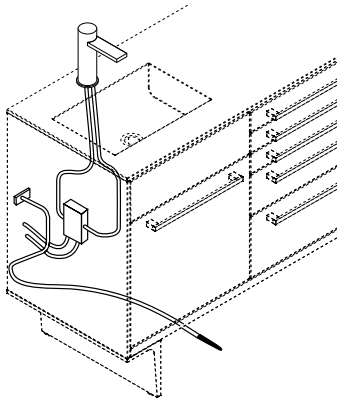
|   | Descrizione / Description<br>Description / Beschreibung / Descripción   | M <sup>3</sup><br>Kg | Articolo<br>Item / Article<br>Artikel / Artículo |
|---|---|----------------------|--|
|  <p><b>P 12 x H 638 mm</b></p>           | <p><b>Tamponamento posteriore verniciato:<br/>al metro lineare</b></p> <p>Painted closing back panel: per meter<br/>Cache de fermeture à l'arrière, verni: au mètre<br/>Lackierte Verschlußverkleidung: je Meter<br/>Panel trasero, pintado: al m.</p>                                    | -<br>5               | TV   |
|  <p><b>P 12 x H 638 mm</b></p>          | <p><b>Tamponamento posteriore in stratificato:<br/>al metro lineare</b></p> <p>Stratified closing back panel: per meter<br/>Cache de fermeture à l'arrière, en stratifié:<br/>au mètre<br/>Verschlußverkleidung aus Schichtstoff: je Meter<br/>Panel trasero, de estratificado: al m.</p> | -<br>8               | TS   |
|  <p><b>P 12 x H 638 mm</b></p>         | <p><b>Tamponamento posteriore in Corian®:<br/>al metro lineare</b></p> <p>Corian® closing back panel: per meter<br/>Cache de fermeture à l'arrière, en Corian®:<br/>au mètre<br/>Verschlußverkleidung aus Corian®: je Meter<br/>Panel trasero, de Corian®: al m.</p>                      | -<br>10              | TC   |
|  <p><b>L 30 x P 480 x H 843 mm</b></p> | <p><b>Pannello laterale verniciato di sostegno piano</b></p> <p>Painted top-support side panel<br/>Panneau latéral verni, de support pour le plan<br/>Lackierte Abschlußverkleidung<br/>Panel lateral pintado para el soporte de la<br/>encimera</p>                                      | -<br>8               | VSL5   |
|                                        | <p><b>Kit comando elettromagnetico 24V ad asta</b></p> <p>24V electromagnetic control kit<br/>Kit commande électromagnétique 24V<br/>pour l'eau<br/>Elektromagnetischer Wasserauslöser 24V<br/>Kit de control electromagnético 24V</p>  | -<br>1               | VKEL   |

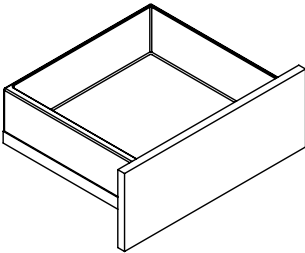
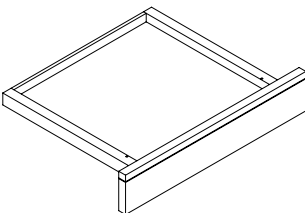
|   | <b>Descrizione / Description</b><br>Description / Beschreibung / Descripción  |          | <b>M<sup>3</sup></b><br><b>Kg</b> | <b>Articolo</b><br>Item / Article<br>Artikel / Artículo |
|---|---|----------|-----------------------------------|---|
|    | <b>CASSETTO con maniglia</b><br>Drawer with handle<br>Tiroir avec poignée<br>Schublade mit Griff<br>Cajón con tirador   | A) H 75  | -<br>5,7                          | VCAAM   |
|   |   | B) H 150 | -<br>6,6                          | VCABM   |
|   |   | C) H 225 | -<br>7,3                          | VCACM   |
|   |   | D) H 300 | -<br>7,8                          | VCADM   |
|  | <b>CASSETTO Push-Pull</b><br>Drawer Push-Pull<br>Tiroir Push-Pull<br>Schublade Push-Pull<br>Cajón Push-Pull   | A) H 75  | -<br>5,5                          | VCAAP   |
|   |   | B) H 150 | -<br>6,4                          | VCABP   |
|   |   | C) H 225 | -<br>7,1                          | VCACP   |
|   |   | D) H 300 | -<br>7,6                          | VCADP   |
|  | <b>CASSETTO per tastiera</b><br><b>(L 385 - H 30 mm max)</b><br>Drawer for keyboard (L 385 - H 30 mm)<br>Tiroir pour clavier (L 385 - H 30 mm)<br>Schublade für Tastatur (L 385 - H 30 mm)<br>Cajón porta teclado (L 385 - H 30 mm) | A) H 75  | -<br>5,5                          | VCAAPK  |

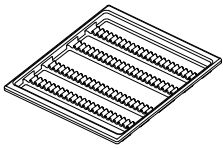
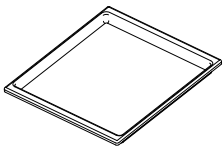
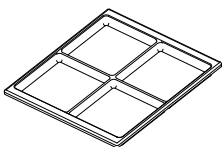
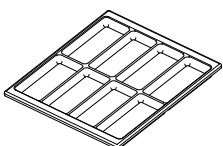
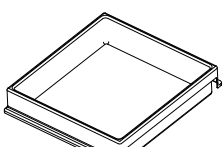
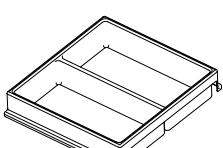
|   | <b>Descrizione / Description</b><br>Description / Beschreibung / Descripción   | <b>M<sup>3</sup></b><br><b>Kg</b> | <b>Articolo</b><br>Item / Article<br>Artikel / Artículo |
|---|--|-----------------------------------|---|
|  <p><b>L 440 x P 389 x H 31 mm</b></p>   | <p><b>BACINELLA con rastrelliera portastrumenti, per cassetto A</b><br/>                     Instrument compartment drawer tray, for drawer A<br/>                     Intérieur de tiroir porte-instruments, pour tiroir A<br/>                     Einsatz mit Instrumentenhalter, für Schublade A<br/>                     Bandeja porta instrumentos, para cajón A</p> | <p>-<br/>0,5</p>                  | <p>VBA1</p>   |
|  <p><b>L 440 x P 389 x H 31 mm</b></p>   | <p><b>BACINELLA piana, per cassetto A</b><br/>                     Flat drawer tray, for drawer A<br/>                     Intérieur de tiroir bas, pour tiroir A<br/>                     Niedriger Einsatz, für Schublade A<br/>                     Bandeja plana, para cajón A</p>   | <p>-<br/>0,5</p>                  | <p>VBA2</p>   |
|  <p><b>L 440 x P 389 x H 31 mm</b></p>  | <p><b>BACINELLA a 4 settori, per cassetto A</b><br/>                     Drawer tray with 4 compartments, for drawer A<br/>                     Intérieur de tiroir à 4 secteurs, pour tiroir A<br/>                     4-Fächern Einsatz, für Schublade A<br/>                     Bandeja con 4 sectores, para cajón A</p>  | <p>-<br/>0,5</p>                  | <p>VBA3</p>   |
|  <p><b>L 440 x P 389 x H 31 mm</b></p> | <p><b>BACINELLA a 8 settori, per cassetto A</b><br/>                     Drawer tray with 8 compartments, for drawer A<br/>                     Intérieur de tiroir à 8 secteurs, pour tiroir A<br/>                     8-Fächern Einsatz, für Schublade A<br/>                     Bandeja con 8 sectores, para cajón A</p>  | <p>-<br/>0,5</p>                  | <p>VBA4</p>   |
|  <p><b>L 400 x P 389 x H 90 mm</b></p> | <p><b>BACINELLA piana, per cassetto B</b><br/>                     Flat drawer tray, for drawer B<br/>                     Intérieur de tiroir bas, pour tiroir B<br/>                     Niedriger Einsatz, für Schublade B<br/>                     Bandeja plana, para cajón B</p>   | <p>-<br/>0,9</p>                  | <p>VBB1</p>   |
|  <p><b>L 400 x P 389 x H 90 mm</b></p> | <p><b>BACINELLA a 2 settori, per cassetto B</b><br/>                     Drawer tray with 2 compartment, for drawer B<br/>                     Intérieur de tiroir à 2 secteurs, pour tiroir B<br/>                     2-Fächern Einsatz, für Schublade B<br/>                     Bandeja con 2 sectores, para cajón B</p>   | <p>-<br/>0,9</p>                  | <p>VBB2</p>   |

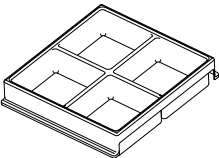
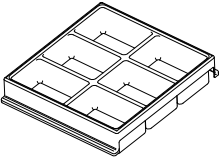
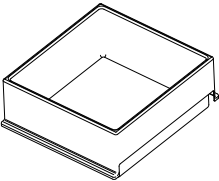
|   | <b>Descrizione</b> / Description<br>Description / Beschreibung / Descripción   | <b>M<sup>3</sup></b><br><b>Kg</b> | <b>Articolo</b><br>Item / Article<br>Artikel / Artículo |
|---|--|-----------------------------------|---|
| <br><b>L 400 x P 389 x H 90 mm</b>   | <b>BACINELLA a 4 settori, per cassetto B</b><br>Drawer tray with 4 compartments, for drawer B<br>Intérieur de tiroir à 4 secteurs, pour tiroir B<br>4-Fächern Einsatz, für Schublade B<br>Bandeja con 4 sectores, para cajón B | -<br>-----<br>0,9                 | VBB3  |
| <br><b>L 400 x P 389 x H 90 mm</b>   | <b>BACINELLA a 6 settori, per cassetto B</b><br>Drawer tray with 6 compartments, for drawer B<br>Intérieur de tiroir à 6 secteurs, pour tiroir B<br>6-Fächern Einsatz, für Schublade B<br>Bandeja con 6 sectores, para cajón B | -<br>-----<br>0,9                 | VBB4  |
| <br><b>L 400 x P 389 x H 165 mm</b> | <b>BACINELLA piana, per cassetti C e D</b><br>Flat drawer tray, for drawers C and D<br>Intérieur de tiroir bas, pour tiroirs C et D<br>Niedriger Einsatz, für Schubladen C und D<br>Bandeja plana, para cajones C y D          | -<br>-----<br>1,1                 | VBC1  |

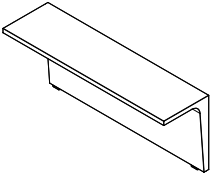
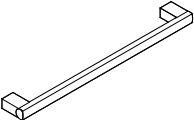
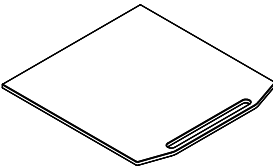
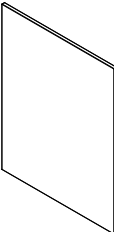
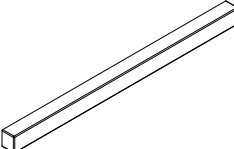
|   | <b>Descrizione</b> / Description<br>Description / Beschreibung / Descripción  |   | <b>M<sup>3</sup></b><br><b>Kg</b> | <b>Articolo</b><br>Item / Article<br>Artikel / Artículo |
|---|---|---|-----------------------------------|---|
|    | <b>PIEDE in alluminio</b><br>Aluminium foot<br>Pied en aluminium<br>Aluminiumfuß<br>Pata de aluminio  | DX / RH<br>Droite / Rechts<br>Dcho  | -<br>-----<br>8                   | VPAD  |
|   |   | SX / LH<br>Gauche / Links<br>Izq  | -<br>-----<br>8                   | VPAS  |
|    | <b>MANIGLIA in alluminio per "Vela"</b><br>Aluminium handle for "Vela"<br>Poignée en aluminium pour "Vela"<br>Griff aus Aluminium für "Vela"<br>Tirador de aluminio para "Vela"             |   | -<br>-----<br>0,4                 | MA010   |
|  | <b>PIANO sagomato per servomobile</b><br>Shaped top for movable unit<br>Plan façonné pour module mobile<br>Geformte Arbeitsplatte für Rollenschrank<br>Encimera perfilada para módulo móvil | <b>Stratificato</b><br>Stratified / Stratifié<br>Schichtstoff<br>Estratificado  | -<br>-----<br>5,5                 | VPSS  |
|   |   | <b>Corian®</b>  | -<br>-----<br>6,2                 | VPSC  |
|   |   | <b>Vetro / Glass</b><br>Verre / Glas / Vidrio                                   | -<br>-----<br>10,8                | VPSV  |
|   |   | <b>Extra-chiaro</b><br>Extra clear<br>Transparent<br>Transparent<br>Extra-claro |                                   |   |
|   |   | <b>Satinato / Satin</b><br>Dépoli / Satiniert Satinado                          |                                   |   |
|  | <b>FIANCO laterale</b><br>Lateral side<br>Panneau latéral<br>Seitenwand<br>Panel lateral  | <b>Verniciato</b><br>Painted / Verni<br>Lackiert / Pintado                      | -<br>-----<br>3,5                 | VFV   |
|   |   | <b>Stratificato</b><br>Stratified / Stratifié<br>Schichtstoff<br>Estratificado  | -<br>-----<br>6,1                 | VFS   |
|   |   | <b>Corian®</b>  | -<br>-----<br>6,9                 | VFC   |
|  | <b>BORDO di finitura (ogni modulo)</b><br>Finish profile (each unit)<br>Bord de finissage (chaque module)<br>Abschlussleiste (jedes Schrank)<br>Borde de acabado (cada módulo)              | <b>Verniciato</b><br>Painted / Verni<br>Lackiert / Pintado                      | -<br>-----<br>0,7                 | BPV05   |
|   |   | <b>Stratificato</b> Stratified /<br>Stratifié<br>Schichtstoff<br>Estratificado  | -<br>-----<br>-<br>-----<br>-     | BPS05   |
|   |   | <b>Corian®</b>  | -<br>-----<br>-                   | BPC05   |

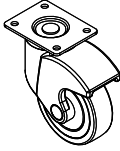
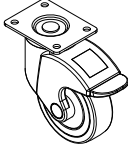
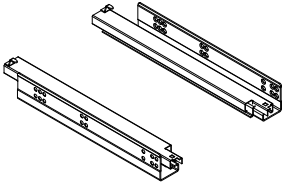
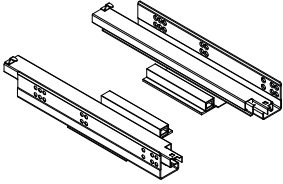

|   | <b>Descrizione</b> / Description<br>Description / Beschreibung / Descripción  | <b>M<sup>3</sup></b><br><b>Kg</b> | <b>Articolo</b><br>Item / Article<br>Artikel / Artículo |
|---|---|-----------------------------------|---|
|    | <p><b>RUOTA senza freno</b><br/>Castor without brake<br/>Roue sans frein<br/>Rad ohne Bremse<br/>Rueda sin freno</p>  | <p>-<br/>-----<br/>0,6</p>        | <p>RUO15</p>  |
|    | <p><b>RUOTA con freno</b><br/>Castor with brake<br/>Roue avec frein<br/>Rad mit Bremse<br/>Rueda con freno</p>  | <p>-<br/>-----<br/>0,7</p>        | <p>RUO16</p>  |
|  | <p><b>COPPIA DI GUIDE con rientro<br/>ammortizzato</b><br/>Pair of guides with soft closing<br/>Couple de glissières avec amortisseur<br/>Eine Paar Führungen mit Softeinzug<br/>Par de guías con cierre suave</p>                        | <p>-<br/>-----<br/>1,7</p>        | <p>GUI23</p>  |
|  | <p><b>COPPIA DI GUIDE per cassetto<br/>Push-Pull</b><br/>Pair of guides for Push-Pull drawer<br/>Couple de glissières pour tiroir Push-Pull<br/>Eine Paar Führungen für Push-Pull<br/>Schublade<br/>Par de guías para cajón Push-Pull</p> | <p>-<br/>-----<br/>1,9</p>        | <p>GUI24</p>  |

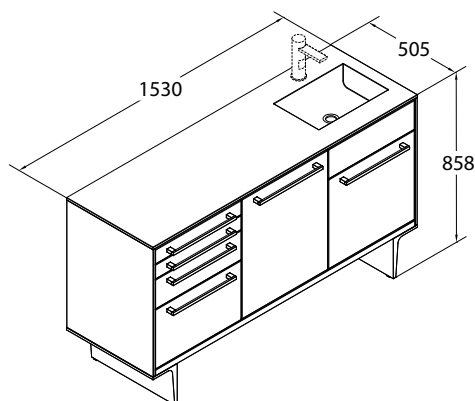

|   |  |       |
|---|--|-------|
| 1 | <b>Piano in stratificato e fianchi verniciati</b><br>Stratified top and painted sides / Plan stratifié et panneaux latéraux vernis /<br>Arbeitsplatte aus Schichtstoff und lackierte Seitenwände /<br>Encimera de estratificado y laterales pintados | + VFA |
| 2 | <b>Piano in vetro e fianchi verniciati</b><br>Glass top and painted sides / Plan en verre et côtés peints /<br>Arbeitsplatte aus Glas und lackierte Seitenwände /<br>Encimera de vidrio y laterales pintados   | + VIV |
| 3 | <b>Piano in Corian® e fianchi verniciati</b><br>Corian® top and painted sides / Plan en Corian® et panneaux latéraux vernis /<br>Arbeitsplatte aus Corian® und lackierte Seitenwände /<br>Encimera de Corian® y laterales pintados                   | + VIC |
| 4 | <b>Piano e fianchi in Corian®</b><br>Corian® top and Corian® sides / Plan et panneau latéraux en Corian® /<br>Arbeitsplatte und Seitenwände aus Corian® /<br>Encimera y laterales de Corian®   | + VIC |

**A** **Composizione / Composition**  
Composition / Zusammenstellung / Composición

V4C + VPA + VLB

**La composizione è comprensiva di bacinelle standard. Rubinetto escluso.**

Trays included. Mixer excluded

Intérieurs de tiroirs inclus. Robinet pas compris.

Standard Schubladeneinsätze sind enthalten. Armatur ist ausgeschlossen.

La composición incluye bandejas estándar. Grifo excluido.

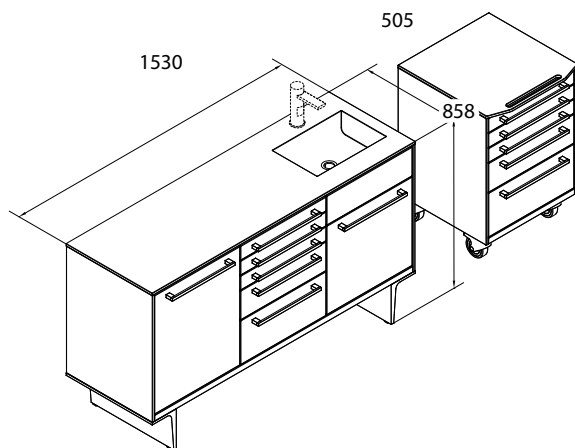

|   |  |       |
|---|--|-------|
| 1 | <b>Piano in stratificato e fianchi verniciati</b><br>Stratified top and painted sides / Plan stratifié et panneaux latéraux vernis /<br>Arbeitsplatte aus Schichtstoff und lackierte Seitenwände /<br>Encimera de estratificado y laterales pintados | + VFA |
| 2 | <b>Piano in vetro e fianchi verniciati</b><br>Glass top and painted sides / Plan en verre et côtés peints /<br>Arbeitsplatte aus Glas und lackierte Seitenwände /<br>Encimera de vidrio y laterales pintados   | + VIV |
| 3 | <b>Piano in Corian® e fianchi verniciati</b><br>Corian® top and painted sides / Plan en Corian® et panneaux latéraux vernis /<br>Arbeitsplatte aus Corian® und lackierte Seitenwände /<br>Encimera de Corian® y laterales pintados                   | + VIC |
| 4 | <b>Piano e fianchi in Corian®</b><br>Corian® top and Corian® sides / Plan et panneau latéraux en Corian® /<br>Arbeitsplatte und Seitenwände aus Corian® /<br>Encimera y laterales de Corian®   | + VIC |

**B** **Composizione / Composition**  
Composition / Zusammenstellung / Composición

VPA + V5A + VLB + V5A + KR

**La composizione è comprensiva di bacinelle standard. Rubinetto escluso.**

Trays included. Mixer excluded

Intérieurs de tiroirs inclus. Robinet pas compris.

Standard Schubladeneinsätze sind enthalten. Armatur ist ausgeschlossen.

La composición incluye bandejas estándar. Grifo excluido.

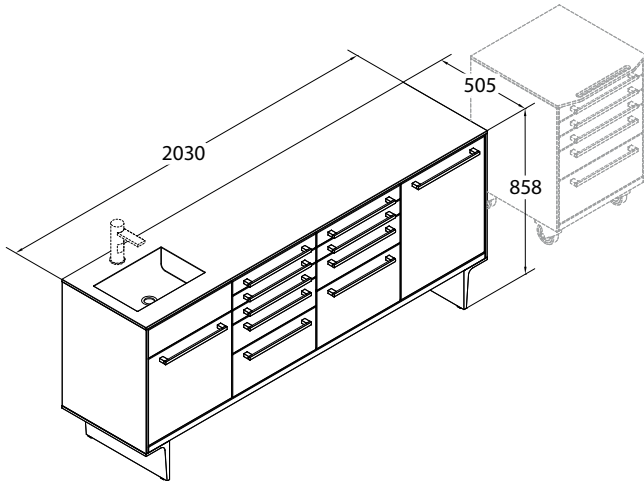

- |   |  |
|---|--|
| 1 | <b>Piano in stratificato e fianchi verniciati</b><br>Stratified top and painted sides / Plan stratifié et panneaux latéraux vernis /<br>Arbeitsplatte aus Schichtstoff und lackierte Seitenwände / + VFA<br>Encimera de estratificado y laterales pintados |
| 2 | <b>Piano in vetro e fianchi verniciati</b><br>Glass top and painted sides / Plan en verre et côtés peints /<br>Arbeitsplatte aus Glas und lackierte Seitenwände / + VIV<br>Encimera de vidrio y laterales pintados   |
| 3 | <b>Piano in Corian® e fianchi verniciati</b><br>Corian® top and painted sides / Plan en Corian® et panneaux latéraux vernis /<br>Arbeitsplatte aus Corian® und lackierte Seitenwände / + VIC<br>Encimera de Corian® y laterales pintados                   |
| 4 | <b>Piano e fianchi in Corian®</b><br>Corian® top and Corian® sides / Plan et panneau latéraux en Corian® /<br>Arbeitsplatte und Seitenwände aus Corian® / + VIC<br>Encimera y laterales de Corian®   |

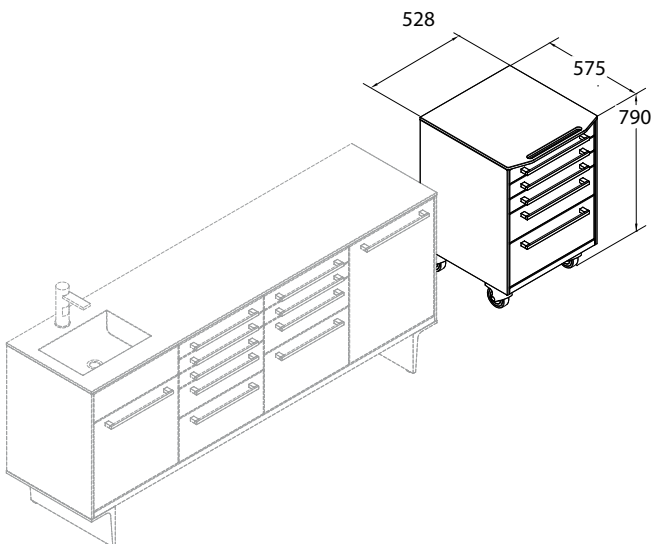

- |   |  |
|---|--|
| 1 | <b>Piano in stratificato e fianchi verniciati</b><br>Stratified top and painted sides / Plan stratifié et panneaux latéraux vernis /<br>Arbeitsplatte aus Schichtstoff und lackierte Seitenwände /<br>Encimera de estratificado y laterales pintados |
| 2 | <b>Piano in vetro e fianchi verniciati</b><br>Glass top and painted sides / Plan en verre et côtés peints /<br>Arbeitsplatte aus Glas und lackierte Seitenwände /<br>Encimera de vidrio y laterales pintados   |
| 3 | <b>Piano in Corian® e fianchi verniciati</b><br>Corian® top and painted sides / Plan en Corian® et panneaux latéraux vernis /<br>Arbeitsplatte aus Corian® und lackierte Seitenwände /<br>Encimera de Corian® y laterales pintados                   |
| 4 | <b>Piano e fianchi in Corian®</b><br>Corian® top and Corian® sides / Plan et panneau latéraux en Corian® /<br>Arbeitsplatte und Seitenwände aus Corian® /<br>Encimera y laterales de Corian®   |

**C** **Composizione** / Composition  
Composition / Zusammenstellung / Composición

VLB + V5A + V4C + VPA

**La composizione è comprensiva di bacinelle standard. Rubinetto escluso.**

Trays included. Mixer excluded

Intérieurs de tiroirs inclus. Robinet pas compris.

Standard Schubladeneinsätze sind enthalten. Armatur ist ausgeschlossen.

La composición incluye bandejas estándar. Grifo excluido.

**C** **Servomobile** / Composition  
Composition / Zusammenstellung / Composición

V5A + KR

**Il servomobile è comprensivo di bacinelle standard.**

Trays included.

Intérieurs de tiroirs inclus.

Standard Schubladeneinsätze sind enthalten.

La composición incluye bandejas estándar.

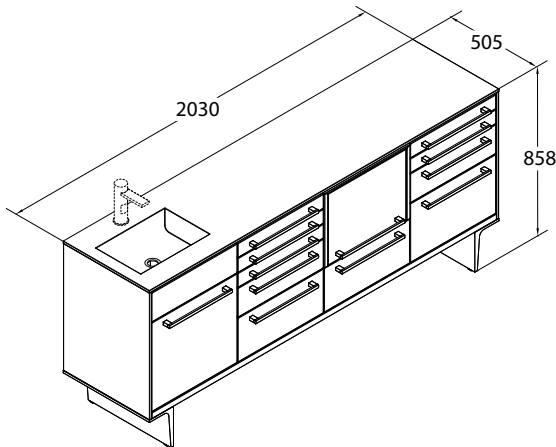

|   |  |
|---|--|
| 1 | <b>Piano in stratificato e fianchi verniciati</b><br>Stratified top and painted sides / Plan stratifié et panneaux latéraux vernis /<br>Arbeitsplatte aus Schichtstoff und lackierte Seitenwände / + VFA<br>Encimera de estratificado y laterales pintados |
| 2 | <b>Piano in vetro e fianchi verniciati</b><br>Glass top and painted sides / Plan en verre et côtés peints /<br>Arbeitsplatte aus Glas und lackierte Seitenwände / + VIV<br>Encimera de vidrio y laterales pintados   |
| 3 | <b>Piano in Corian® e fianchi verniciati</b><br>Corian® top and painted sides / Plan en Corian® et panneaux latéraux vernis /<br>Arbeitsplatte aus Corian® und lackierte Seitenwände / + VIC<br>Encimera de Corian® y laterales pintados                   |
| 4 | <b>Piano e fianchi in Corian®</b><br>Corian® top and Corian® sides / Plan et panneau latéraux en Corian® /<br>Arbeitsplatte und Seitenwände aus Corian® / + VIC<br>Encimera y laterales de Corian®   |

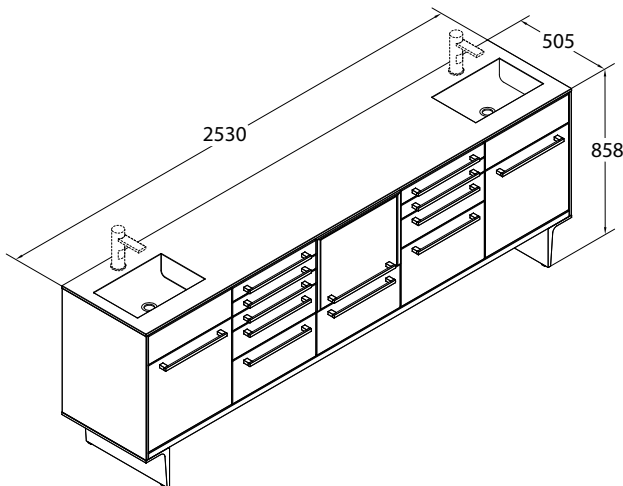

|   |  |
|---|--|
| 1 | <b>Piano in stratificato e fianchi verniciati</b><br>Stratified top and painted sides / Plan stratifié et panneaux latéraux vernis /<br>Arbeitsplatte aus Schichtstoff und lackierte Seitenwände / + VFA<br>Encimera de estratificado y laterales pintados |
| 2 | <b>Piano in vetro e fianchi verniciati</b><br>Glass top and painted sides / Plan en verre et côtés peints /<br>Arbeitsplatte aus Glas und lackierte Seitenwände / + VIV<br>Encimera de vidrio y laterales pintados   |
| 3 | <b>Piano in Corian® e fianchi verniciati</b><br>Corian® top and painted sides / Plan en Corian® et panneaux latéraux vernis /<br>Arbeitsplatte aus Corian® und lackierte Seitenwände / + VIC<br>Encimera de Corian® y laterales pintados                   |
| 4 | <b>Piano e fianchi in Corian®</b><br>Corian® top and Corian® sides / Plan et panneau latéraux en Corian® /<br>Arbeitsplatte und Seitenwände aus Corian® / + VIC<br>Encimera y laterales de Corian®   |

**D** **Composizione / Composition**  
Composition / Zusammenstellung / Composición

VLB + V5A + VRA + V4C

**La composizione è comprensiva di bacinelle standard. Rubinetto escluso.**

Trays included. Mixer excluded

Intérieurs de tiroirs inclus. Robinet pas compris.

Standard Schubladeneinsätze sind enthalten. Armatur ist ausgeschlossen.

La composición incluye bandejas estándar.

Grifo excluido.

**E** **Composizione / Composition**  
Composition / Zusammenstellung / Composición

VLB + V5A + VRA + V4C + VLB

**La composizione è comprensiva di bacinelle standard. Rubinetto escluso.**

Trays included. Mixer excluded

Intérieurs de tiroirs inclus. Robinet pas compris.

Standard Schubladeneinsätze sind enthalten. Armatur ist ausgeschlossen.

La composición incluye bandejas estándar.

Grifo excluido.

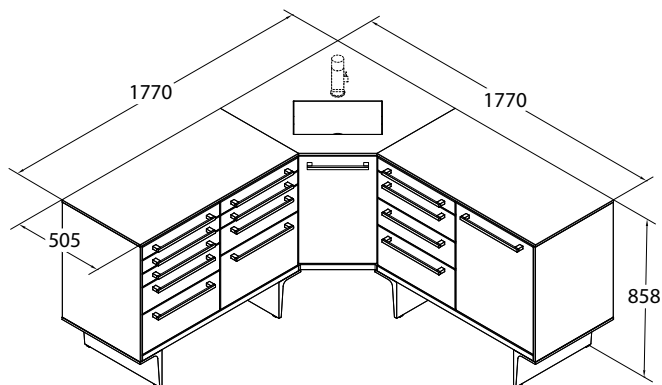

|          |  |             |
|----------|--|-------------|
| <b>1</b> | <b>Piano in stratificato e fianchi verniciati</b><br>Stratified top and painted sides / Plan stratifié et panneaux latéraux vernis /<br>Arbeitsplatte aus Schichtstoff und lackierte Seitenwände /<br>Encimera de estratificado y laterales pintados | <b>+VFA</b> |
| <b>2</b> | <b>Piano in vetro e fianchi verniciati</b><br>Glass top and painted sides / Plan en verre et côtés peints /<br>Arbeitsplatte aus Glas und lackierte Seitenwände /<br>Encimera de vidrio y laterales pintados   | <b>+VIT</b> |
| <b>3</b> | <b>Piano in Corian® e fianchi verniciati</b><br>Corian® top and painted sides / Plan en Corian® et panneaux latéraux vernis /<br>Arbeitsplatte aus Corian® und lackierte Seitenwände /<br>Encimera de Corian® y laterales pintados                   | <b>+VIC</b> |
| <b>4</b> | <b>Piano e fianchi in Corian®</b><br>Corian® top and Corian® sides / Plan et panneau latéraux en Corian® /<br>Arbeitsplatte und Seitenwände aus Corian® /<br>Encimera y laterales de Corian®   | <b>+VIC</b> |

**F** **Composizione** / Composition  
Composition / Zusammenstellung / Composición

V5A + V4C + VAA + V4A + VPA

**La composizione è comprensiva di bacinelle standard. Rubinetto escluso.**

Trays included. Mixer excluded

Intérieurs de tiroirs inclus. Robinet pas compris.

Standard Schubladeneinsätze sind enthalten. Armatur ist ausgeschlossen.

La composición incluye bandejas estándar.

Grifo excluido.

# Vela - Armonya - Start

Piani / Tops / Plans / Arbeitsplatten / Encimeras

**Loran**  
everyday passion

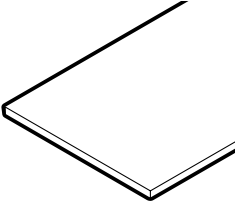
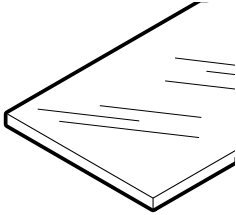
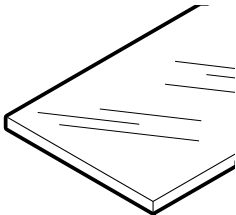
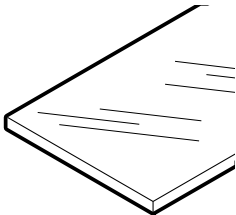
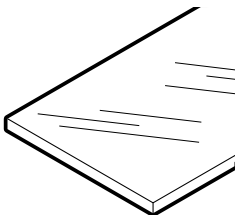
|  | <b>Descrizione</b> / Description<br>Description / Beschreibung / Descripción | <b>M<sup>3</sup></b><br><b>Kg</b> | <b>Articolo</b><br>Item / Article<br>Artikel / Artículo |
|--|--|-----------------------------------|---|
|  <p><b>Piano in Corian® bianco: al metro lineare</b><br/>White Corian® top: per meter<br/>Plan en Corian® blanc: au mètre<br/>Weiß Corian® Arbeitsplatte: je Meter<br/>Encimera de Corian® blanco: al m.</p>  |  | -<br>11                           | CB<br>(P 505 mm)  |
|  | <p><b>P 505 x H 12 mm</b><br/><b>P 600 x H 12 mm</b></p>                     |                                   | -<br>13   |
|  <p><b>Piano in vetro: al metro lineare</b><br/>Glass top: per meter<br/>Plan en verre: au mètre<br/>Glasarbeitsplatte: je Meter<br/>Encimera de vidrio: al m.</p>  |  | -<br>19                           | VB  |
| <p><b>P 505 x H 15 mm</b></p>  |  |                                   |   |
|  <p><b>Piano in vetro satinato: al metro lineare</b><br/>Glass top satin: per meter<br/>Plan en verre dépoli: au mètre<br/>Satinierte Glasarbeitsplatte: je Meter<br/>Encimera de vidrio satinado: al m.</p>  |  | -<br>19                           | XB  |
| <p><b>P 505 x H 15 mm</b></p>  |  |                                   |   |
|  <p><b>Piano in vetro extra-chiaro: al metro lineare</b><br/>Extra clear glass top: per meter<br/>Plan en verre transparent: au mètre<br/>Transparente Glasarbeitsplatte: je Meter<br/>Encimera de vidrio transparente: al m.</p>   |  | -<br>19                           | YB  |
| <p><b>P 505 x H 15 mm</b></p>  |  |                                   |   |
|  <p><b>Piano in vetro extra-chiaro satinato: al metro lineare</b><br/>Extra-clear glass top satin: per meter<br/>Plan en verre transparent dépoli: au mètre<br/>Transparente satinierte Glasarbeitsplatte: je Meter<br/>Encimera de vidrio transparente satinado: al m.</p> |  | -<br>19                           | ZB  |
| <p><b>P 505 x H 15 mm</b></p>  |  |                                   |   |

# Vela - Armonya - Start

Piani / Tops / Plans / Arbeitsplatten / Encimeras

**Loran**  
everyday passion

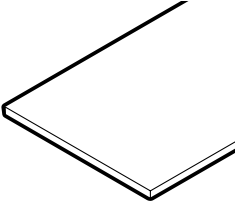
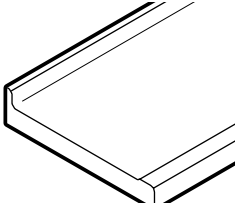
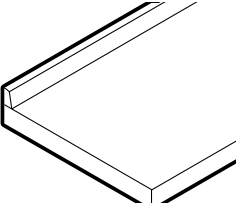
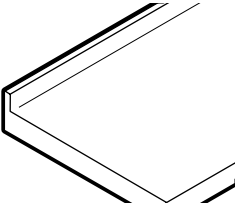
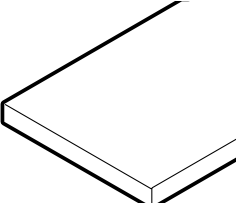
|   | <b>Descrizione / Description</b><br>Description / Beschreibung / Descripción | <b>M<sup>3</sup></b><br><b>Kg</b> | <b>Articolo</b><br>Item / Article<br>Artikel / Artículo |
|---|--|-----------------------------------|---|
|  <p><b>Piano in stratificato bianco: al metro lineare</b><br/>White stratified top: per meter<br/>Plan en stratifié blanc: au mètre<br/>Weiß Schichtstoffarbeitsplatte: je Meter<br/>Encimera de estratificado blanco: al m.</p> <p><b>P 505 x H 12 mm</b><br/><b>P 600 x H 12 mm</b></p>  |  | -<br>9,6                          | SB<br>(P 505 mm)  |
|   |  | -<br>11,4                         | SD<br>(P 600 mm)  |
|  <p><b>Piano in laminato con alzatina incorporata H 45 mm: al metro lineare</b><br/>Laminated top with rear trim H 45 mm: per meter<br/>Plan en laminé avec dossier H 45 mm: au mètre<br/>Laminatarbeitsplatte mit Aufkantung H 45 mm: je Meter<br/>Encimera de laminado con elevación H 45 mm: al m.</p> <p><b>P 460 x H 30 mm</b><br/><b>P 520 x H 30 mm</b></p>   |  | -<br>10                           | BA<br>(P 460 mm)  |
|   |  | -<br>11                           | BC<br>(P 520 mm)  |
|  <p><b>Piano in laminato con alzatina applicata ALB H 40 mm: al metro lineare</b><br/>Laminated top with applied rear trim ALB H 40 mm: per meter<br/>Plan en laminé avec dossier appliqué ALB H 40 mm: au mètre<br/>Laminatarbeitsplatte mit aufgeklebter Aufkantung ALB H 40 mm: je Meter<br/>Encimera de laminado con elevación aplicado ALB H 40 mm: al m.</p> <p><b>P 460 x H 30 mm</b><br/><b>P 520 x H 30 mm</b><br/><b>P 600 x H 30 mm</b></p> |  | -<br>10                           | TA<br>(P 460 mm)  |
|   |  | -<br>11                           | TC<br>(P 520 mm)  |
|   |  | -<br>12                           | TD<br>(P 600 mm)  |
|  <p><b>Piano in acciaio inox con alzatina incorporata H 70 mm: al metro lineare</b><br/>Stainless steel top with rear trim H 70 mm: per meter<br/>Plan en acier inox avec dossier H 70 mm: au mètre<br/>Edelstahlarbeitsplatte mit Aufkantung H 70 mm: je Meter<br/>Encimera de acero inox con elevación H 70 mm: al m.</p> <p><b>P 520 x H 30 mm</b><br/><b>P 600 x H 30 mm</b></p>   |  | -<br>14                           | HC<br>(P 520 mm)  |
|   |  | -<br>18                           | HD<br>(P 600 mm)  |
|  <p><b>Piano in acciaio inox senza alzatina: al metro lineare</b><br/>Stainless steel top: per meter<br/>Plan en acier inox : au mètre<br/>Edelstahlarbeitsplatte: je Meter<br/>Encimera de acero inox: al m.</p> <p><b>P 520 x H 30 mm</b><br/><b>P 600 x H 30 mm</b></p>   |  | -<br>13                           | IC<br>(P 520 mm)  |
|   |  | -<br>15                           | ID<br>(P 600 mm)  |

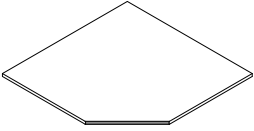
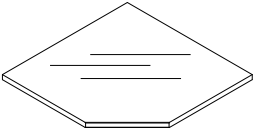
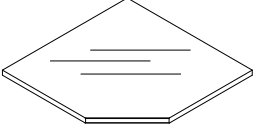
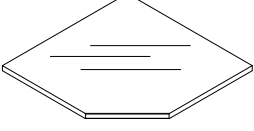
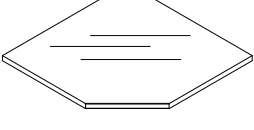
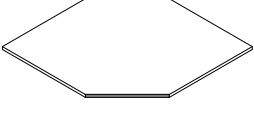
|   | <b>Descrizione / Description</b><br>Description / Beschreibung / Descripción   | <b>M<sup>3</sup></b><br><b>Kg</b> | <b>Articolo</b><br>Item / Article<br>Artikel / Artículo |
|---|--|-----------------------------------|---|
|    | <p><b>Piano angolare in Corian® bianco</b><br/>White Corian® top for corner units<br/>Plan en Corian® blanc pour modules d'angle<br/>Weiß Corian® Arbeitsplatte für Eckschränke<br/>Encimera de Corian® blanco para módulos angulares</p>  | -<br>11,6                         | CBV   |
| <b>L 755 x P 755 x H 12 mm</b>  |  |                                   |   |
|    | <p><b>Piano angolare in vetro</b><br/>Glass top for corner units<br/>Plan en verre pour modules d'angle<br/>Glasarbeitsplatte für Eckschränke<br/>Encimera de vidrio para módulos angulares</p>  | -<br>20,2                         | VBV   |
| <b>L 755 x P 755 x H 15 mm</b>  |  |                                   |   |
|  | <p><b>Piano angolare in vetro satinato</b><br/>Glass top satin for corner units<br/>Plan en verre dépoli pour modules d'angle<br/>Satinierte Glasarbeitsplatte für Eckschränke<br/>Encimera de vidrio satinado para módulos angulares</p>  | -<br>20,2                         | XBV   |
| <b>L 755 x P 755 x H 15 mm</b>  |  |                                   |   |
|  | <p><b>Piano angolare in vetro extra-chiaro</b><br/>Extra-clear glass top for corner units<br/>Plan en verre transparent pour modules d'angles<br/>Transparente Glasarbeitsplatte für Eckschränke<br/>Encimera de vidrio transparente para módulos angulares</p>  | -<br>20,2                         | YBV   |
| <b>L 755 x P 755 x H 15 mm</b>  |  |                                   |   |
|  | <p><b>Piano angolare in vetro extra-chiaro satinato</b><br/>Extra clear glass top satin for corner units<br/>Plan en verre transparent dépoli pour modules d'angles<br/>Transparente satinierte Glasarbeitsplatte für Eckschränke<br/>Encimera de vidrio trasparente satinado para módulos angulares</p> | -<br>20,2                         | ZBV   |
| <b>L 755 x P 755 x H 15 mm</b>  |  |                                   |   |
|  | <p><b>Piano angolare in stratificato bianco</b><br/>White stratified top for corner units<br/>Plan en stratifié blanc pour modules d'angles<br/>Weiß Schichtstoffarbeitsplatte für Eckschränke<br/>Encimera de estratificado blanco para módulos angulares</p>   | -<br>10,2                         | SBV   |
| <b>L 755 x P 755 x H 12 mm</b>  |  |                                   |   |



# Vela - Armonya - Start

Alzatine / Splashbacks / Dosserets / Aufkantungen / Alzadas

**Loran**  
everyday passion

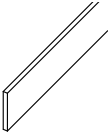
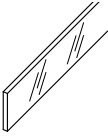
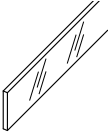
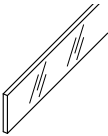
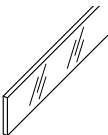
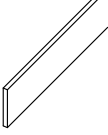
|  | <b>Descrizione / Description</b><br>Description / Beschreibung / Descripción  | <b>M<sup>3</sup></b><br><b>Kg</b> | <b>Articolo</b><br>Item / Article<br>Artikel / Artículo |
|--|---|-----------------------------------|---|
| <br><b>SP 12 x H 80 mm</b><br><b>SP 12 x H 12 mm</b>    | <b>Alzatina in Corian® bianco: al metro lineare</b><br>White Corian® splashback: per meter<br>Dosseret en Corian® blanc: au mètre<br>Weiß Corian® Aufkantung: je Meter<br>Alzada de Corian® blanco: al m.   | -<br>1,5                          | AC08<br>(H 80 mm)                                       |
|  |   | -<br>0,3                          | AC01<br>(H 12 mm)                                       |
| <br><b>SP 15 x H 80 mm</b><br><b>SP 15 x H 100 mm</b>   | <b>Alzatina in vetro: al metro lineare</b><br>Glass splashback: per meter<br>Dosseret en verre: au mètre<br>Glasaufkantung: je Meter<br>Alzada de vidrio: al m.   | -<br>3                            | AV08<br>(H 80 mm)                                       |
|  |   | -<br>3,8                          | AV10<br>(H 100 mm)                                      |
| <br><b>SP 15 x H 80 mm</b><br><b>SP 15 x H 100 mm</b>  | <b>Alzatina in vetro satinato: al metro lineare</b><br>Glass splashback satin: per meter<br>Dosseret en verre dépoli: au mètre<br>Satinierte Glasaufkantung: je Meter<br>Alzada de vidrio satinado: al m.   | -<br>3                            | AX08<br>(H 80 mm)                                       |
|  |   | -<br>3,8                          | AX10<br>(H 100 mm)                                      |
| <br><b>SP 15 x H 80 mm</b><br><b>SP 15 x H 100 mm</b> | <b>Alzatina in vetro extra-chiaro: al metro lineare</b><br>Extra-clear glass splashback: per meter<br>Dosseret en verre transparent: au mètre<br>Transparente Glasaufkantung: e Meter<br>Alzada de vidrio transparente: al m.   | -<br>3                            | AY08<br>(H 80 mm)                                       |
|  |   | -<br>3,8                          | AY10<br>(H 100 mm)                                      |
| <br><b>SP 15 x H 80 mm</b><br><b>SP 15 x H 100 mm</b> | <b>Alzatina in vetro extra-chiaro satinato: al metro lineare</b><br>Extra-clear glass splashback satin: per meter<br>Dosseret en verre transparent dépoli: au mètre<br>Transparente satinierte Glasaufkantung: e Meter<br>Alzada de vidrio transparente satinado: al m. | -<br>3                            | AZ08<br>(H 80 mm)                                       |
|  |   | -<br>3,8                          | AZ10<br>(H 100 mm)                                      |
| <br><b>SP 12 x H 80 mm</b><br><b>SP 12 x H 100 mm</b> | <b>Alzatina in stratificato bianco: al metro lineare</b><br>White stratified splashback: per meter<br>Dosseret en stratifié blanc: au mètre<br>Weiß Schichtstoffaufkantung: je Meter<br>Alzada de estratificado blanco: al m.   | -<br>1,5                          | AS08<br>(H 80 mm)                                       |
|  |   | -<br>1,8                          | AS10<br>(H 100 mm)                                      |

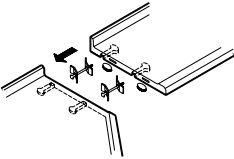
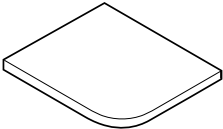
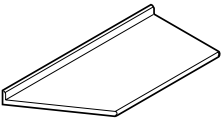
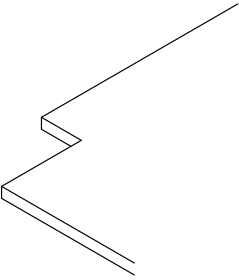
|   | <b>Descrizione</b> / Description<br>Description / Beschreibung / Descripción   | <b>M<sup>3</sup></b><br><b>Kg</b> | <b>Articolo</b><br>Item / Article<br>Artikel / Artículo |
|---|--|-----------------------------------|---|
|    | <p><b>Set collegamento 2 piani laminato</b><br/>Worktop-connection set<br/>Set pour la liaison de 2 plans de travail<br/>Set für Zusammenbau von Arbeitsplatten<br/>Juego para la unión de las 2 encimeras</p> |                                   | SCP   |
|    | <p><b>Arrotondamento spigolo del piano</b><br/>Corner-rounding for top<br/>Angle arrondi pour le plan de travail<br/>Abgerundete Kanten der Arbeitsplatte<br/>Angulo redondeado de la encimera</p>             |                                   |   |
|   | <b>Corian®</b>   |                                   | ARC   |
|   | <b>Vetro</b> / Glass / Verre / Glas / Vidrio   |                                   | ARV   |
|   | <b>Stratificato</b> / Stratified / Stratifié / Schichtstoff / Estratificado  |                                   | ARS   |
|   | <b>Laminato</b> / Laminate / Laminé / Laminat / Laminado   |                                   | ARP   |
|   | <b>Acciaio inox</b> / Stainless steel / Acier Inox<br>Edelstahl / Acero inoxidable   |                                   | ARI   |
|  | <p><b>Taglio obliquo su piano</b><br/>Special cut of top<br/>Découpe spéciale sur le plan de travail<br/>Sonderschnitt der Arbeitsplatte<br/>Corte especial sobre la encimera</p>                              |                                   |   |
|   | <b>Corian®</b>   |                                   | TSC   |
|   | <b>Vetro</b> / Glass / Verre / Glas / Vidrio   |                                   | TSV   |
|   | <b>Stratificato</b> / Stratified / Stratifié / Schichtstoff / Estratificado  |                                   | TSS   |
|   | <b>Laminato</b> / Laminate / Laminé / Laminat / Laminado   |                                   | TSP   |
|   | <b>Acciaio inox</b> / Stainless steel / Acier Inox<br>Edelstahl / Acero inoxidable   |                                   | TSI   |
|  | <p><b>Taglio a "L" su piano</b><br/>Special cut of top<br/>Découpe spéciale sur le plan de travail<br/>Sonderschnitt der Arbeitsplatte<br/>Corte especial sobre la encimera</p>                                |                                   |   |
|   | <b>Corian®</b>   |                                   | T1C   |
|   | <b>Vetro</b> / Glass / Verre / Glas / Vidrio   |                                   | T1V   |
|   | <b>Stratificato</b> / Stratified / Stratifié / Schichtstoff / Estratificado  |                                   | T1S   |
|   | <b>Laminato</b> / Laminate / Laminé / Laminat / Laminado   |                                   | T1P   |
|   | <b>Acciaio inox</b> / Stainless steel / Acier Inox<br>Edelstahl / Acero inoxidable   |                                   | T1I   |

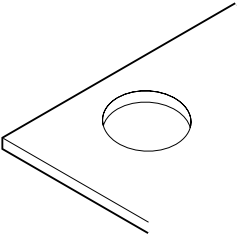
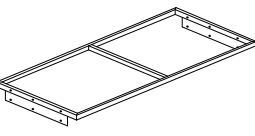
|  | <b>Descrizione / Description</b><br>Description / Beschreibung / Descripción   | <b>M<sup>3</sup></b><br><b>Kg</b> | <b>Articolo</b><br>Item / Article<br>Artikel / Artículo |
|--|--|-----------------------------------|---|
|   | <p><b>Foro Ø 150 mm su piano, per rifiuti</b><br/>                     Waste hole Ø 150 mm for top<br/>                     Trou passage déchets Ø 150 mm, pour plan<br/>                     Abfallloch Ø 150 mm für Arbeitsplatte<br/>                     Agujero Ø 150 mm para la basura, sobre encimera</p>   |                                   |   |
|  | <p><b>Corian®</b></p>  |                                   | FRC   |
|  | <p><b>Vetro / Glass / Verre / Glas / Vidrio</b></p>  |                                   | FRV   |
|  | <p><b>Stratificato / Stratified / Stratifié / Schichtstoff / Estratificado</b></p>   |                                   | FRS   |
|  | <p><b>Laminato / Laminare / Laminé / Laminat / Laminado</b></p>  |                                   | FRT   |
|  | <p><b>Telaio supporto piano a sbalzo per piani Corian®, vetro, stratificato: al metro lineare</b><br/>                     Frame to support the top in Corian®, glass, stratified<br/>                     Châssis pour soutenir le plan en Corian®, verre, stratifié<br/>                     Rahmen für Arbeitsplatte aus Corian®, Glas, Schichtstoff<br/>                     Frame para apoyar las encimeras de Corian®, vidrio, estratificado</p> |                                   | STS   |

# Vela - Armonya - Start

Lavelli / Sinks / Evers / Waschbecken / Lavabos

**Loran**  
everyday passion

**Descrizione** / Description  
Description / Beschreibung / Descripción

**M<sup>3</sup>**  
**Kg**

**Articolo**  
Item / Article  
Artikel / Artículo

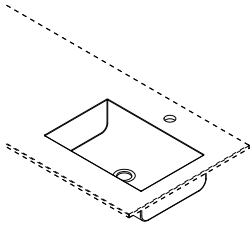

## Lavello integrato in Corian®

Integrated Corian® sink  
Evier intégré en Corian®  
Integrierte Waschbecken aus Corian®  
Lavabo integrado de Corian®

**L 400 x P 260 x H 110 mm**

VIC

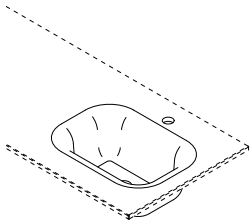

## Lavello termoformato in Corian®

Integrated thermoformed Corian® sink  
Evier intégré thermoformé en Corian®  
Integriertes tiefgezogenes Waschbecken aus Corian®  
Lavabo integrado termoformato de Corian®

**L 400 x P 300 x H 130 mm**

VTC

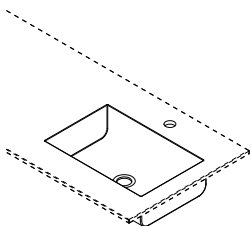

## Lavello sottopiano in acciaio inox, per piani in Corian® e stratificato

Undermont stainless steel sink, for Corian® and stratified top  
Evier en inox, pour plans en Corian® et stratifié  
Unterbauedelstahlwaschbecken, für Arbeitsplatte aus Corian®  
und Schichtstoff  
Lavabo bajo encimera de acero para encimeras de  
Corian® y estratificado

**L 400 x P 270 x H 195 mm**

VFA

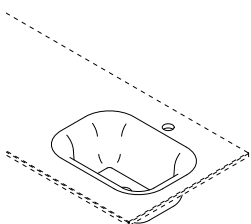

## Lavello integrato in vetro

Integrated glass sink  
Evier intégré en verre  
Integriertes, tiefgezogenes Glaswaschbecken  
Lavabo integrado de vidrio

**NB: piani lineari L 2800 mm max.** / Straight tops L 2800 mm max. /  
Plans linéaires L 2800 mm max. / Gerade Arbeitsplatte L 2800 mm max. /  
Encimera lineal L 2800 mm max.

**L 400 x P 300 x H 130 mm**

VIV

# Vela - Armonya - Start

Lavelli / Sinks / Evers / Waschbecken / Lavabos

**Loran**  
everyday passion

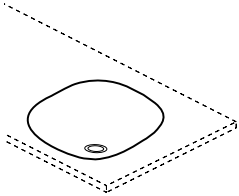
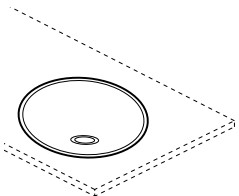
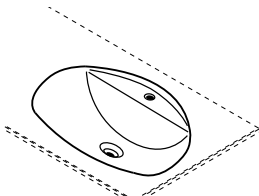
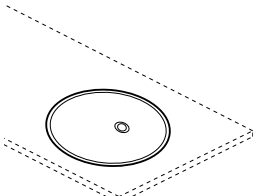
|   | <b>Descrizione</b> / Description<br>Description / Beschreibung / Descripción   | <b>M<sup>3</sup></b><br><b>Kg</b> | <b>Articolo</b><br>Item / Article<br>Artikel / Artículo |
|---|--|-----------------------------------|---|
|    | <p><b>Lavello integrato in vetro (NO satinato / NO angolare)</b><br/>                     Integrated glass sink (NOT satin / NOT corner)<br/>                     Evier intégré en verre (PAS dépoli / PAS d'angle)<br/>                     Integrierte Glaswaschbecken (NICHT satiniert / NICHT Ecke)<br/>                     Lavabo integrado de vidrio (NO satinado / NO angular)</p> <p><b>NB: piani lineari L 2100 mm max. (solo all'estremità sx o dx del piano) /</b><br/>                     Straight tops L 2100 mm max. (only at the right or left end of the top)<br/>                     Plans linéaires L 2100 mm max. (uniquement à l'extrémité gauche ou droite du plan)<br/>                     Gerade Arbeitsplatte L 2100 mm max. (nur am linken oder rechten Ende der Arbeitsplatte)<br/>                     Encimera lineal L 2100 mm max. (sólo en el extremo izdo. o dcho. de la encimera)</p> |                                   |   |
| <b>L 320 x P 320 mm</b>   |  |                                   | VI  |
|   | <p><b>Lavello a semisfera in acciaio inox sopra piano</b><br/>                     Top mounted stainless steel sink<br/>                     Evier en inox sur plan<br/>                     Aufgesetztes Edelstahlwaschbecken<br/>                     Lavabo de acero sobre encimera</p> <p><b>NB: si consiglia il rubinetto RB3 / mixer RB3 suggested / robinet RB3 conseillé /</b><br/>                     Wasserhahn RB3 empfohlen / se aconseja el grifo RB3</p>  |                                   |   |
| <b>Ø 340 mm - H 160 mm</b>  |  | 1                                 | VAS   |
|  | <p><b>Lavello in ceramica a filo piano</b><br/>                     Flush ceramic bowl<br/>                     Evier porcelaine collée sous le plan<br/>                     Porzellanwaschbecken bündig mit der Arbeitsplatte<br/>                     Lavabo de cerámica a ras de la encimera</p>   |                                   |   |
|   | <b>Laminato</b> / Laminato / Laminé / Laminat / Laminado   | 7,2                               | VCF   |
| <b>L 455 x P 405 mm</b>   | <b>Stratificato</b> / Stratified / Stratifié / Schichtstoff / Estratificado  | 7,2                               | VCS   |
|  | <p><b>Lavello in acciaio smaltato</b><br/>                     Enamel steel sink<br/>                     Evier en acier inox émaillé<br/>                     Aufgesetztes emailiertes Stahl-Waschbecken<br/>                     Lavabo de acero esmaltado</p>   |                                   |   |
| <b>Ø 340 mm - H 160 mm</b>  |  | 1                                 | VSS   |

# Vela - Armonya - Start

Rubinetti / Mixers / Robinets / Wasserhähne / Grifos

**Loran**  
everyday passion

**Descrizione** / Description  
Description / Beschreibung / Descripción

**M<sup>3</sup>**  
**Kg**

**Articolo**  
Item / Article  
Artikel / Artículo

**Per lo STUDIO** / For DENTAL OFFICE /- Pour le CABINET / Für PRAXIS / Por el ESTUDIO

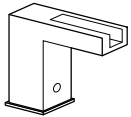

### Rubinetto "a cascata" con fotocellula

Mixer "a cascata" with photoelectric cell  
Robinet électronique "a cascata" à photocellule  
Elektronische Wasserhahn "a cascata" mit Fotozelle  
Grifo "a cascata" con fotocélula

-  
4

RB8

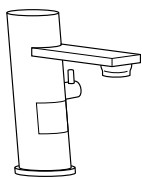

### Rubinetto con fotocellula

Mixer with photoelectric cell  
Robinet électronique à photocellule  
Elektronische Wasserhahn mit Fotozelle  
Grifo con fotocélula

-  
3

RB7

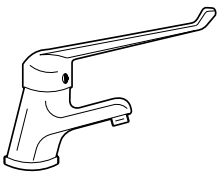

### Rubinetto cromato a leva lunga

Chromed mixer with long lever  
Robinet chromé à levier long  
Verchromte Wasserhahn mit langem Hebel  
Grifo cromado con palanca larga

-  
1,5

RB2

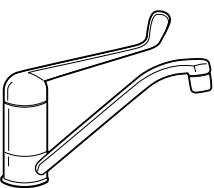

### Rubinetto cromato con collo lungo e leva lunga

Chromed mixer with long neck and long lever  
Robinet chromé à col long et levier long  
Verchromte Langrohr- und Langhebel-Wasserhahn  
Grifo cromado con caño largo y palanca larga

-  
1,5

RB3

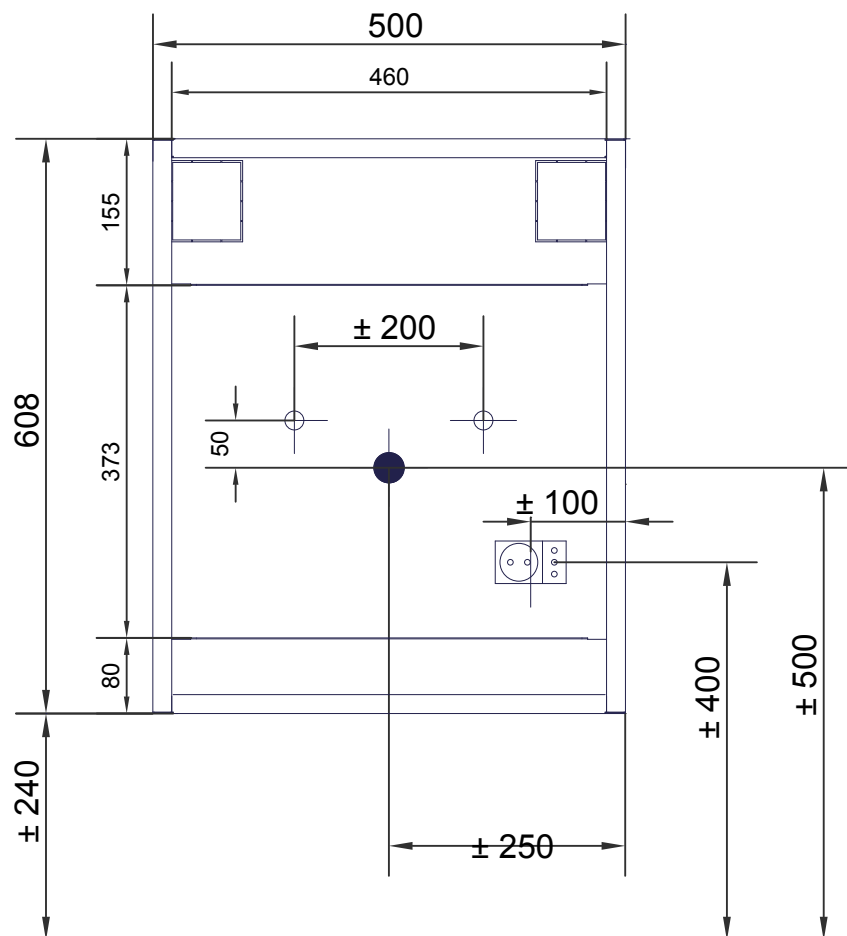

# Colori

Colors / Couleurs / Farben / Colores

**Loran**  
everyday passion

Finiture verniciate / Painted finishes / Finitions peintes / Lackierten Ausführungen / Acabados pintados

|                 |                 |                 |                 |                 |                 |                        |
|-----------------|-----------------|-----------------|-----------------|-----------------|-----------------|------------------------|
|                 |                 |                 |                 |                 |                 |                        |
| <b>BIANCO</b>   | <b>RAL 1015</b> | <b>RAL 1018</b> | <b>RAL 1023</b> | <b>RAL 2001</b> | <b>RAL 2012</b> | <b>RAL3000</b>         |
|                 |                 |                 |                 |                 |                 |                        |
| <b>RAL 3004</b> | <b>RAL 3016</b> | <b>RAL 4002</b> | <b>RAL 4006</b> | <b>RAL 5000</b> | <b>RAL 5002</b> | <b>RAL 5010</b>        |
|                 |                 |                 |                 |                 |                 |                        |
| <b>RAL 5012</b> | <b>RAL 5014</b> | <b>RAL 5022</b> | <b>RAL 5024</b> | <b>RAL 6000</b> | <b>RAL 6019</b> | <b>RAL 6027</b>        |
|                 |                 |                 |                 |                 |                 |                        |
| <b>RAL 7016</b> | <b>RAL 7022</b> | <b>RAL 7038</b> | <b>RAL 7045</b> | <b>RAL 8019</b> | <b>RAL 9001</b> | <b>RAL 9002</b>        |
|                 |                 |                 |                 |                 |                 |                        |
| <b>RAL 9005</b> | <b>SILVER</b>   | <b>APRICOT</b>  | <b>602 PLA</b>  | <b>C3526</b>    | <b>GLICINE</b>  | <b>SILBER METALLIC</b> |

**Colorazioni speciali con maggiorazione di prezzo / Special colors with upcharge / Couleurs spéciales avec supplément de prix / Sonderfarben gegen einem Aufpreis / Coloraciones especiales disponibles por un cargo adicional**

Colori piani in vetro / Colors of the glass tops / Couleurs des plans en verre / Farben der Glasarbeitsplatten / Colores de las encimeras de vidrio

Vetro extra-chiaro / Extra clear glass / Verre transparent / Transparent Glas / Vidrio transparente

|                 |                 |                      |                        |                |                             |                |
|-----------------|-----------------|----------------------|------------------------|----------------|-----------------------------|----------------|
|                 |                 |                      |                        |                |                             |                |
| <b>TURCHESE</b> | <b>LIMONE</b>   | <b>VERDE ACQUA</b>   | <b>VERDE</b>           | <b>GIALLO</b>  | <b>AZZURRO MEDITERRANEO</b> | <b>GLICINE</b> |
|                 |                 |                      |                        |                |                             |                |
| <b>CELESTE</b>  | <b>BLU CINA</b> | <b>ROSSO GRANATA</b> | <b>ROSSO VENEZIANO</b> | <b>SALMONE</b> | <b>GIALLO NEVADA</b>        | <b>BIANCO</b>  |

Questo campionario deve essere considerato solo come guida indicativa del colore e non può essere utilizzato come riferimento originale per la produzione e la valutazione di superfici colorate.

This sample should only be considered as an indicative colour guide and cannot be used as an original reference for the production and assessment of colored surfaces.

Ce nuancier ne sert qu'à donner une idée des différents coloris et ne doit en aucun cas être utilisé comme référence originale pour la production et l'évaluation des surfaces colorées.

Diese Farbmuster sind unverbindlich und können vom Original Farbton der hergestellten Oberflächen abweichen.

Esta muestra de colores debe considerarse sólo como una guía indicativa del color, y no puede utilizarse como referencia original para la producción y evaluación de las superficies pintadas.



| Descrizione / Description<br>Description / Beschreibung / Descripción | M <sup>3</sup><br>Kg | Articolo<br>Item / Article<br>Artikel / Artículo |
|---|----------------------|--|
|---|----------------------|--|



L 1030 x P 200 x H 400 mm

**PENSILE CON ANTA A RIBALTA VERNICIATA**

Wall unit with painted pull-up door / Élément mural avec porte vernie avec ouverture vers le haut / Hängeschrank mit lackierten Tür mit Öffnung nach oben / Mueble colgante con puerta pintada con apertura hacia arriba

0,15  
32

ALA10

**PENSILE CON ANTA A RIBALTA IN VETRO**

Wall unit with glass pull-up door / Élément mural avec porte en verre avec ouverture vers le haut / Hängeschrank mit Glastür mit Öffnung nach oben / Mueble colgante con puerta de vidrio con apertura hacia arriba

0,15  
30

ALA10V

**PENSILE CON ANTA A RIBALTA A SPECCHIO**

Wall units with mirror pull-up door / Élément mural avec porte avec miroir avec ouverture vers le haut / Hängeschrank mit Spiegeltür mit Öffnung nach oben / Mueble colgante con puerta con espejo con apertura hacia arriba

0,15  
30

ALA10S

Completo di:

n. 1 distributore di bicchieri; n. 1 distributore di sapone automatico con fotocellula;  
 n. 2 alloggiamenti per guanti o salviette; n. 1 alloggiamento per mascherine;  
 n. 2 portarotolo per carta e mantelline.

Complete of:

n. 1 glass dispenser; n. 1 photocell-controlled soap dispenser;  
 n. 2 spaces for gloves and serviettes; n. 1 place for face masks;  
 n. 2 paper roll and cape carriers.

Composé de:

n. 1 distributeur de gobelets; n. 1 distributeur de savon automatique avec cellule photoélectrique;  
 n. 2 logements pour gants ou serviettes; n. 1 logement pour masques;  
 n. 2 supports de rouleau pour papier et capes.

Komplett mit:

n. 1 Verteiler von Bechern; n. 1 automatischer Seifenspender mit Lichtschranke;  
 n. 2 Platz für Handschuhe oder Servietten; n. 1 Steckplatz für Maskern;  
 n. 2 Papierrollenträger und Schulterumhänge.

Dotado de:

n. 1 dispensador de vasos; n. 1 dispensador de jabón automático con fotocélula;  
 n. 2 alojamiento para guantes servilletas; n. 1 alojamiento para mascarillas; n. 1 alojamiento para mordazas y/o cánulas; n. 2 porta rollo para papel y capas.

| Descrizione / Description<br>Description / Beschreibung / Descripción | M <sup>3</sup><br>Kg | Articolo<br>Item / Article<br>Artikel / Artículo |
|---|----------------------|--|
|---|----------------------|--|



L 1530 x P 200 x H 400 mm

**PENSILE CON ANTA A RIBALTA VERNICIATA**

Wall unit with painted pull-up door / Élément mural avec porte vernie avec ouverture vers le haut / Hängeschrank mit lackierten Tür mit Öffnung nach oben / Mueble colgante con puerta pintada con apertura hacia arriba

0,22  
51

ALA15

**PENSILE CON ANTA A RIBALTA IN VETRO**

Wall unit with glass pull-up door / Élément mural avec porte en verre avec ouverture vers le haut / Hängeschrank mit Glastür mit Öffnung nach oben / Mueble colgante con puerta de vidrio con apertura hacia arriba

0,22  
49

ALA15V

**PENSILE CON ANTA A RIBALTA A SPECCHIO**

Wall units with mirror pull-up door / Élément mural avec porte avec miroir avec ouverture vers le haut / Hängeschrank mit Spiegeltür mit Öffnung nach oben / Mueble colgante con puerta con espejo con apertura hacia arriba

0,22  
49

ALA15S

Completo di:

n. 1 distributore di bicchieri; n. 1 distributore di sapone automatico con fotocellula;  
n. 3 alloggiamenti per guanti o salviette; n. 1 alloggiamento per mascherine;  
n. 1 alloggiamento per bavagli o canule; n. 2 portarotolo per carta e mantelline.

Complete of:

n. 1 glass dispenser; n. 1 photocell-controlled soap dispenser;  
n. 3 spaces for gloves and serviettes; n. 1 place for face masks;  
n. 1 place for bibs and cannulas; n. 2 paper roll and cape carriers.

Composé de:

n. 1 distributeur de gobelets; n. 1 distributeur de savon automatique avec cellule photoélectrique; n. 3 logements pour gants ou serviettes; n. 1 logement pour masques;  
n. 1 logement pour bavoires ou canules; n. 2 supports de rouleau pour papier et capes.

Komplett mit:

n. 1 Verteiler von Bechern; n. 1 automatischer Seifenspender mit Lichtschranke;  
n. 3 Platz für Handschuhe oder Servietten; n. 1 Steckplatz für Masken;  
n. 1 Steckplatz für Lätzchen oder Kanülen; n. 2 Papierrollenträger und Schulterumhänge.

Dotado de:

n. 1 dispensador de vasos; n. 1 dispensador de servilletas; n. 1 dispensador de jabón automático con fotocélula; n. 3 alojamientos para guantes o servilletas;  
n. 1 alojamiento para mascarillas; n. 1 alojamiento para mordazas o cánulas; n. 2 porta rollo para papel y capas.

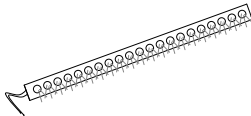
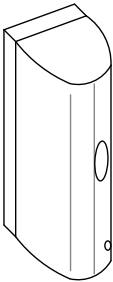
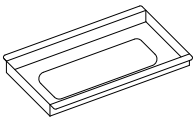
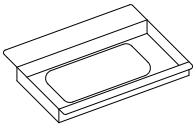
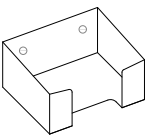
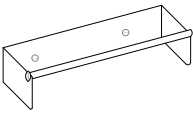
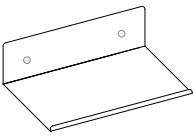
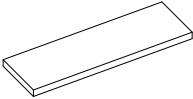
|   | <b>Descrizione / Description</b><br>Description / Beschreibung / Descripción   | <b>Dim.</b><br>Dim. / Dim.<br>Maß / Dim.<br>mm | <b>M<sup>3</sup></b><br>Kg | <b>Articolo</b><br>Item / Article<br>Artikel / Artículo |
|---|--|--|----------------------------|---|
|    | <b>LAMPADA A LED</b><br>LED lamp<br>Lampe à LEDs<br>LED-Leuchte<br>Lámpara de LED  | L = 1030                                       |                            | LED10   |
|   |  | L = 1530                                       |                            | LED15   |
|    | <b>DISTRIBUTORE DI SAPONE AUTOMATICO con fotocellula</b><br>Photocell-controlled SOAP DISPENSER<br>DISTRIBUTEUR DE SAVON AUTOMATIQUE avec cellule photoélectrique<br>AUTOMATISCHER SEIFENSPENDER mit Fotozelle<br>DISPENSADOR DE JABÓN AUTOMÁTICO con fotocélula |  | -<br>1,2                   | DSF   |
|  | <b>ALLOGGIAMENTO per guanti o salviette</b><br>SPACE for gloves and serviettes<br>LOGEMENT pour gants ou serviettes<br>STECKPLATZ für Handschuhe oder Tücher<br>ALOJAMIENTO para guantes o servilletas   | L 240 x P 130                                  | -<br>0,6                   | ALAPG   |
|  | <b>ALLOGGIAMENTO per mascherine</b><br>PLACE for face masks<br>LOGEMENT pour masques<br>STECKPLATZ für Masken<br>ALOJAMIENTO para mascarillas  | L 185 x P 105                                  | -<br>0,5                   | ALAPM   |
|  | <b>ALLOGGIAMENTO per bavagli o canule</b><br>PALCE for bibs and cannulas<br>LOGEMENT pour bavoires ou canules<br>STECKPLATZ für Lätzchen oder Kanülen<br>ALOJAMIENTO para mordazas o cánulas   | L 185 x P 125                                  | -<br>0,9                   | ALAPT   |
|  | <b>PORTAROTOLO per carta o mantelline</b><br>Paper roll and cape CARRIER<br>SUPPORT DE ROULEAU pour papier et capes<br>PAPIERROLLENTÄGER und Schulterumhänge<br>PORTA ROLLO para papel y capas   | L 322  | -<br>0,7                   | ALAPR   |
|  | <b>MENSOLA</b><br>Shelf<br>Etagère<br>Regal<br>Repisa  | L 250  | -0,8                       | ALAME25   |
|   |  | L 500  | -1,6                       | ALAME50   |
|   |  | L 1000   |                            | ALAME100  |
|   |  | L 1500   |                            | ALAME150  |
|  | <b>FONDO</b><br>Bottom<br>Fond<br>Unterseite<br>Parte inferior   | L 1030   | -0,8                       | ALAFO100  |
|   |  | L 1530   | -1,6                       | ALAFO150  |

# Colori

Colors / Couleurs / Farben / Colores

**Loran**  
everyday passion

Finiture verniciate / Painted finishes / Finitions peintes / Lackierten Ausführungen / Acabados pintados

|                 |                 |                 |                 |                 |                 |                        |
|-----------------|-----------------|-----------------|-----------------|-----------------|-----------------|------------------------|
|                 |                 |                 |                 |                 |                 |                        |
| <b>BIANCO</b>   | <b>RAL 1015</b> | <b>RAL 1018</b> | <b>RAL 1023</b> | <b>RAL 2001</b> | <b>RAL 2012</b> | <b>RAL3000</b>         |
|                 |                 |                 |                 |                 |                 |                        |
| <b>RAL 3004</b> | <b>RAL 3016</b> | <b>RAL 4002</b> | <b>RAL 4006</b> | <b>RAL 5000</b> | <b>RAL 5002</b> | <b>RAL 5010</b>        |
|                 |                 |                 |                 |                 |                 |                        |
| <b>RAL 5012</b> | <b>RAL 5014</b> | <b>RAL 5022</b> | <b>RAL 5024</b> | <b>RAL 6000</b> | <b>RAL 6019</b> | <b>RAL 6027</b>        |
|                 |                 |                 |                 |                 |                 |                        |
| <b>RAL 7016</b> | <b>RAL 7022</b> | <b>RAL 7038</b> | <b>RAL 7045</b> | <b>RAL 8019</b> | <b>RAL 9001</b> | <b>RAL 9002</b>        |
|                 |                 |                 |                 |                 |                 |                        |
| <b>RAL 9005</b> | <b>SILVER</b>   | <b>APRICOT</b>  | <b>602 PLA</b>  | <b>C3526</b>    | <b>GLICINE</b>  | <b>SILBER METALLIC</b> |

**Colorazioni speciali con maggiorazione di prezzo / Special colors with upcharge / Couleurs spéciales avec supplément de prix / Sonderfarben gegen einem Aufpreis / Coloraciones especiales disponibles por un cargo adicional**

Colori piani in vetro / Colors of the glass tops / Couleurs des plans en verre / Farben der Glasarbeitsplatten / Colores de las encimeras de vidrio

Vetro extra-chiaro / Extra clear glass / Verre transparent / Transparent Glas / Vidrio transparente

|                 |                 |                      |                        |                |                             |                |
|-----------------|-----------------|----------------------|------------------------|----------------|-----------------------------|----------------|
|                 |                 |                      |                        |                |                             |                |
| <b>TURCHESE</b> | <b>LIMONE</b>   | <b>VERDE ACQUA</b>   | <b>VERDE</b>           | <b>GIALLO</b>  | <b>AZZURRO MEDITERRANEO</b> | <b>GLICINE</b> |
|                 |                 |                      |                        |                |                             |                |
| <b>CELESTE</b>  | <b>BLU CINA</b> | <b>ROSSO GRANATA</b> | <b>ROSSO VENEZIANO</b> | <b>SALMONE</b> | <b>GIALLO NEVADA</b>        | <b>BIANCO</b>  |





Questo campionario deve essere considerato solo come guida indicativa del colore e non può essere utilizzato come riferimento originale per la produzione e la valutazione di superfici colorate.

This sample should only be considered as an indicative colour guide and cannot be used as an original reference for the production and assessment of colored surfaces.

Ce nuancier ne sert qu'à donner une idée des différents coloris et ne doit en aucun cas être utilisé comme référence originale pour la production et l'évaluation des surfaces colorées.

Diese Farbmuster sind unverbindlich und können vom Original Farbton der hergestellten Oberflächen abweichen.

Esta muestra de colores debe considerarse sólo como una guía indicativa del color, y no puede utilizarse como referencia original para la producción y evaluación de las superficies pintadas.

|  | <b>Descrizione / Description</b><br>Description / Beschreibung / Descripción  | <b>M<sup>3</sup></b><br><b>Kg</b> | <b>Articolo</b><br>Item / Article<br>Artikel / Artículo |
|--|---|-----------------------------------|---|
|  <p><b>L 430 x P 500 x H 845 mm</b></p>   | <p><b>CARRELLO PORTA APPARECCHI con prese multiple</b><br/>                     EQUIPMENT-CARRYING TROLLEY with multiple power sockets<br/>                     CARIOT POUR APPAREILS avec prises multiples<br/>                     Gerätetragewagen (Trolley für Geräte) mit Steckdosenleisten<br/>                     CARRO PORTA EQUIPOS con tomas múltiples</p>   | <p>0,22<br/>23</p>                | <p>LUNA</p>   |
|  <p><b>L 430 x P 500 x H 845 mm</b></p>  | <p><b>CARRELLO PORTA APPARECCHI con prese multiple e PANNELLI COLORATI*</b><br/>                     EQUIPMENT-CARRYING TROLLEY with multiple power sockets AND COLOURED PANELS*<br/>                     CARIOT POUR APPAREILS avec prises multiples ET PANNEAUX EN COULEUR*<br/>                     Gerätetragewagen (Trolley für Geräte) mit Steckdosenleisten und farbige Paneele*<br/>                     CARRO PORTA EQUIPOS con tomas múltiples y PANELES DE COLORES*</p> <p>* Tinte RAL / RAL colors / couleurs RAL / RAL Farbe / colores RAL</p>   | <p>0,22<br/>23</p>                | <p>LUNAV</p>  |
|  <p><b>L 430 x P 500 x H 845 mm</b></p> | <p><b>CARRELLO PORTA APPARECCHI con cassetto e prese multiple</b><br/>                     EQUIPMENT-CARRYING TROLLEY with drawer and multiple power sockets<br/>                     CARIOT POUR APPAREILS avec tiroir et prises multiples<br/>                     Gerätetragewagen (Trolley für Geräte) mit Schublade und Steckdosenleisten<br/>                     CARRO PORTA EQUIPOS con cajones y tomas múltiples</p>   | <p>0,22<br/>2,6</p>               | <p>LUNAC</p>  |
|  <p><b>L 430 x P 500 x H 845 mm</b></p> | <p><b>CARRELLO PORTA APPARECCHI con cassetto e prese multiple e PANNELLI COLORATI*</b><br/>                     EQUIPMENT-CARRYING TROLLEY with drawer, multiple power sockets AND COLOURED PANELS*<br/>                     CARIOT POUR APPAREILS avec tiroir, avec prises multiples ET PANNEAUX EN COULEUR*<br/>                     Gerätetragewagen (Trolley für Geräte) mit Schublade, Steckdosenleisten und farbige Paneele*<br/>                     CARRO PORTA EQUIPOS con cajón, tomas múltiples y PANELES DE COLORES*</p> <p>* Tinte RAL / RAL colors / couleurs RAL / RAL Farbe / colores RAL</p> | <p>0,22<br/>26</p>                | <p>LUNACV</p>   |

# Colori

Colors / Couleurs / Farben / Colores

**Loran**  
everyday passion

Finiture verniciate / Painted finishes / Finitions peintes / Lackierten Ausführungen / Acabados pintados

|   |   |   |   |  |   |   |
|---|---|---|---|--|---|---|
|    |    |    |    |    |    |    |
| <b>BIANCO</b>   | <b>RAL 1015</b>   | <b>RAL 1018</b>   | <b>RAL 1023</b>   | <b>RAL 2001</b>  | <b>RAL 2012</b>   | <b>RAL3000</b>  |
|    |    |    |    |    |    |    |
| <b>RAL 3004</b>   | <b>RAL 3016</b>   | <b>RAL 4002</b>   | <b>RAL 4006</b>   | <b>RAL 5000</b>  | <b>RAL 5002</b>   | <b>RAL 5010</b>   |
|    |    |    |    |    |    |    |
| <b>RAL 5012</b>   | <b>RAL 5014</b>   | <b>RAL 5022</b>   | <b>RAL 5024</b>   | <b>RAL 6000</b>  | <b>RAL 6019</b>   | <b>RAL 6027</b>   |
|   |   |   |   |   |   |   |
| <b>RAL 7016</b>   | <b>RAL 7022</b>   | <b>RAL 7038</b>   | <b>RAL 7045</b>   | <b>RAL 8019</b>  | <b>RAL 9001</b>   | <b>RAL 9002</b>   |
|  |  |  |  |  |  |  |
| <b>RAL 9005</b>   | <b>SILVER</b>   | <b>APRICOT</b>  | <b>602 PLA</b>  | <b>C3526</b>   | <b>GLICINE</b>  | <b>SILBER METALLIC</b>  |

**Colorazioni speciali con maggiorazione di prezzo / Special colors with upcharge / Couleurs spéciales avec supplément de prix / Sonderfarben gegen einem Aufpreis / Coloraciones especiales disponibles por un cargo adicional**

Colori piani in vetro / Colors of the glass tops / Couleurs des plans en verre / Farben der Glasarbeitsplatten / Colores de las encimeras de vidrio

Vetro extra-chiaro / Extra clear glass / Verre transparent / Transparent Glas / Vidrio transparente

|   |   |   |   |  |   |   |
|---|---|---|---|--|---|---|
|  |  |  |  |  |  |  |
| <b>TURCHESE</b>   | <b>LIMONE</b>   | <b>VERDE ACQUA</b>  | <b>VERDE</b>  | <b>GIALLO</b>  | <b>AZZURRO MEDITERRANEO</b>   | <b>GLICINE</b>  |
|  |  |  |  |  |  |  |
| <b>CELESTE</b>  | <b>BLU CINA</b>   | <b>ROSSO GRANATA</b>  | <b>ROSSO VENEZIANO</b>  | <b>SALMONE</b>   | <b>GIALLO NEVADA</b>  | <b>BIANCO</b>   |

Questo campionario deve essere considerato solo come guida indicativa del colore e non può essere utilizzato come riferimento originale per la produzione e la valutazione di superfici colorate.

This sample should only be considered as an indicative colour guide and cannot be used as an original reference for the production and assessment of colored surfaces.

Ce nuancier ne sert qu'à donner une idée des différents coloris et ne doit en aucun cas être utilisé comme référence originale pour la production et l'évaluation des surfaces colorées.

Diese Farbmuster sind unverbindlich und können vom Original Farbton der hergestellten Oberflächen abweichen.

Esta muestra de colores debe considerarse sólo como una guía indicativa del color, y no puede utilizarse como referencia original para la producción y evaluación de las superficies pintadas.